

Introduction

The STM32100E-EVAL evaluation board is designed as a complete development platform for the STMicroelectronics ARM® Cortex-M3 core-based STM32F100 microcontroller with HDMI CEC connection, FSMC (Flexible Static Memory Controller), two I²C, three SPI, five USART, 32 Kbytes of internal SRAM, 512 Kbytes of internal Flash memory and JTAG and SWD debugging/programming support.

The full range of hardware features on the board helps you evaluate all peripherals (HDMI CEC, SRAM, motor control, LCD, MicroSD card, serial Flash, EEPROM, temperature sensor, speaker, IrDA, RS-232, RS-485... etc.) and develop your own applications.

Extension headers facilitate the connection of a daughterboard or wrapping board for your specific applications. An ST-LINK/V2 is integrated on the board as an embedded debugger and programmer for the STM32F100 MCU.

Table 1. Applicable tools

Type	Part number
Development tool	STM32100E-EVAL

Figure 1. STM32100E-EVAL evaluation board

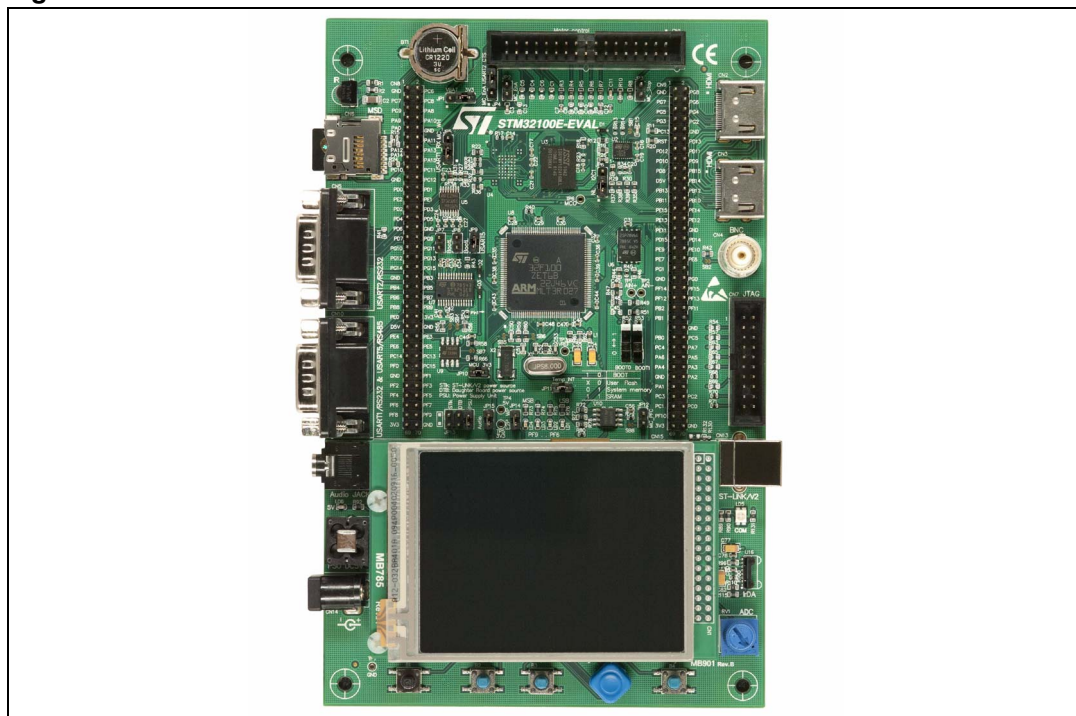

Contents

1	Overview	4
1.1	Features	4
1.2	Demonstration software	4
1.3	Order code	4
2	Hardware layout and configuration	5
2.1	Development and debug support	7
2.2	Power supply	7
2.3	Boot option	9
2.4	Clock source	9
2.5	Reset source	10
2.6	Audio	10
2.7	EEPROM	11
2.8	IrDA	11
2.9	Motor control	11
2.10	MicroSD card	12
2.11	Analog input	13
2.12	SRAM	13
2.13	Serial Flash	13
2.14	Temperature sensor	13
2.15	Display and input devices	14
2.16	HDMI CEC	14
2.17	IR receiver	14
2.18	RS-232 communication	15
2.19	RS-485 communication	15
3	Connectors	16
3.1	Motor control connector CN1	16
3.2	HDMI connectors CN2 and CN3	17
3.3	Analog input connector CN4	17
3.4	RS-232 connector CN5 with RTS/CTS handshake support	18

3.5	RS-232 with ISP support and RS-485 connector CN10	18
3.6	MicroSD connector CN6	19
3.7	JTAG debugging connector CN7	19
3.8	Daughterboard extension connectors CN8 and CN9	20
3.9	Audio jack CN11	25
3.10	ST-LINK/V2 connector CN13 (USB connector)	25
3.11	ST-LINK/V2 programming connector CN12 (reserved connector)	26
3.12	Power connector CN14	26
4	Schematics	27
	Appendix A STM32100E-EVAL pinout	42
	Revision history	47

1 Overview

1.1 Features

- Three 5-V power supply options:
 - Power jack
 - ST-LINK/V2 connector
 - Daughterboard
- Boot from user Flash, system memory or SRAM
- 1 Gbyte (or more) MicroSD card
- 16 Mbytes of serial Flash memory
- 2 Mbytes of SRAM
- 8 Kbytes of EEPROM
- I²C/SMBus compatible serial interface temperature sensor
- 2-channel RS-232 communication interface with RTS/CTS handshake support on one channel
- 1-channel RS-485 communication interface sharing the USART1 connector
- IrDA transceiver
- IR receiver
- Inductor motor control connector
- JTAG and SWD debug support
- 3.2" TFT color LCD with touch screen
- Joystick with 4-direction control and selector
- Reset, wakeup, tamper and user buttons
- Speaker
- 4 LEDs
- RTC with backup battery
- Extension connector for daughterboard or wrapping board
- Embedded ST-LINK/V2 debugger and programmer
- HDMI (High-Definition Multimedia Interface) with Consumer Electronics Control (CEC) connection

1.2 Demonstration software

Demonstration software is preloaded on board Flash memory for easy demonstration of the device peripherals in standalone mode. For more information and to download the latest version available, please refer to STM32100E-EVAL demonstration software available on the web: www.st.com/mcu.

1.3 Order code

To order the STM32F100ZET6 MCU evaluation board, use the order code STM32100E-EVAL.

2 Hardware layout and configuration

The STM32100E-EVAL evaluation board is designed around the STM32F100ZET6 (144-pin LQFP package). The hardware block diagram [Figure 2](#) illustrates the connection between STM32F100ZET6 and peripherals (LCD, SRAM, IR receiver, SPI Flash, USART, IrDA, speaker, HDMI CEC, temperature sensor, MicroSD card, motor control and embedded ST-LINK/V2) and [Figure 3](#) will help you locate these features on the actual evaluation board.

Figure 2. Hardware block diagram

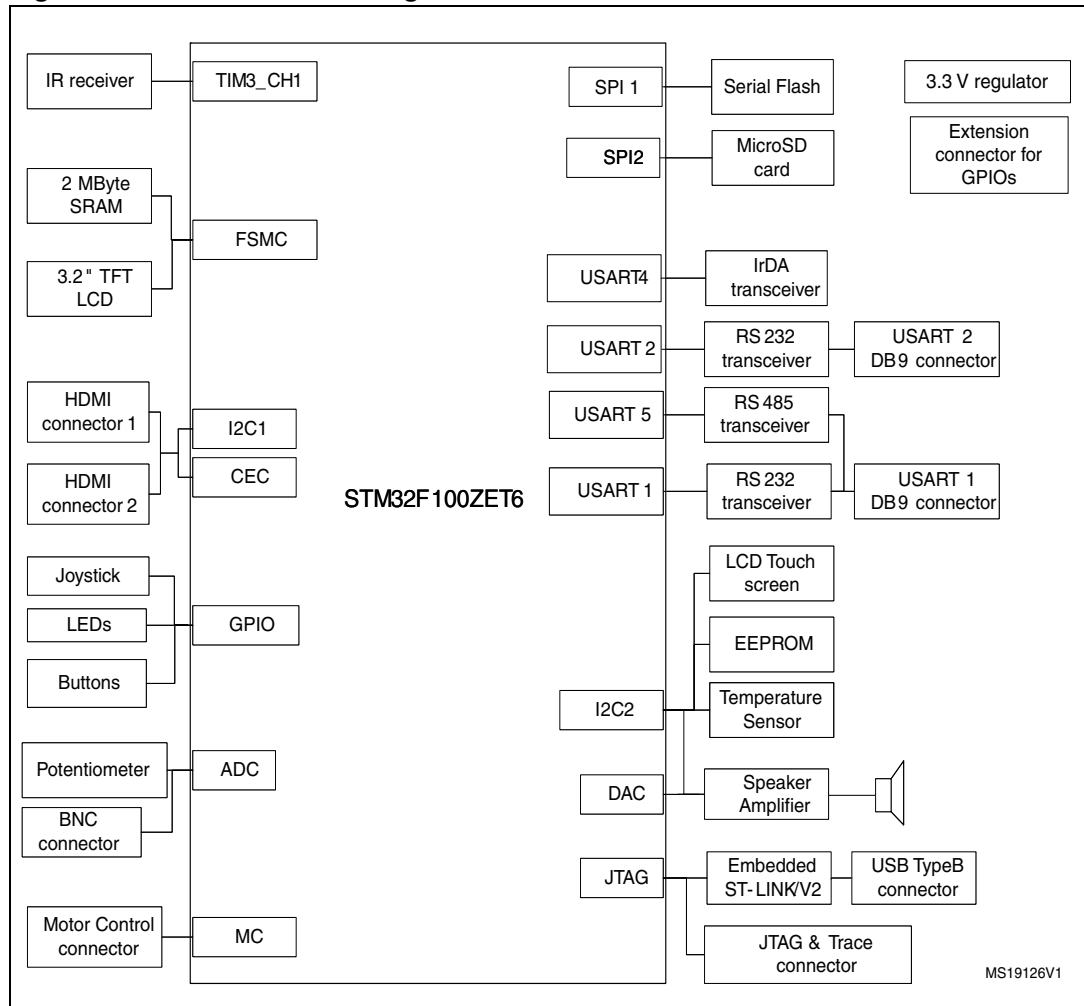
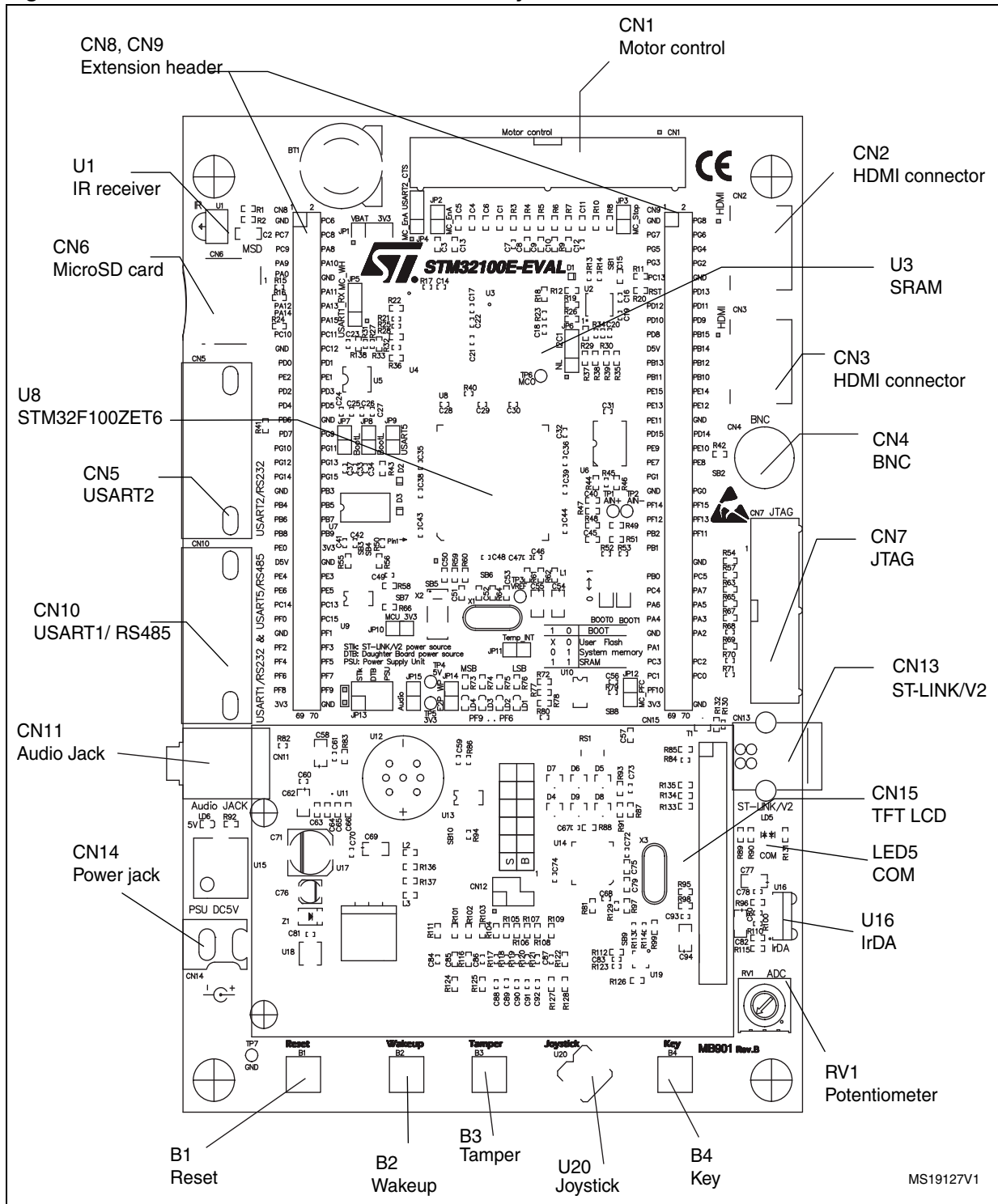

Figure 3. STM32100E-EVAL Evaluation board layout



MS19127V1

2.1 Development and debug support

Version 2 of the ST-LINK, known as ST-LINK/V2, is embedded on the board. This tool allows program loading and debugging of the STM32F using the JTAG or SWD interface. Third-party debug tools are also supported by using the JTAG connector (CN7).

A specific driver needs to be installed on your PC for communication with the embedded ST-LINK/V2. The InstallShield package ST-LINK_V2_USBdriver.exe is available from the ST website. To download and install this driver, please refer to **Software and development tools** page for STM32F family available on www.st.com.

Connect the embedded ST-LINK/V2 to the PC via a standard USB cable from connector CN13. The bi-color LED LD5 (COM in [Figure 3](#)) indicates the status of the communication as follows:

- Slow blinking Red/Off: At power-on before USB initialization
- Fast blinking Red/Off: After the first correct communication between PC and STLink/V2 (enumeration)
- Red LED On: When initialization between PC and ST-LINK/V2 is successfully finished
- Green LED On: After successful target communication initialization
- Blinking Red/Green: During communication with target
- Green On: Communication finished and OK
- Orange On: Communication failure

Note: It is possible to power the board via CN13 (embedded ST-LINK/V2 USB connector) even if an external tool is connected to CN7 (external JTAG and SWD).





2.2 Power supply

STM32100E-EVAL evaluation board is designed to be powered by a 5 V DC power supply and to be protected by PolyZen U18 from damage caused by overvoltage and overcurrent fault conditions. It is possible to configure the evaluation board to use any of following three power supply sources:

- 5V DC power adapter connected to CN14, the Power Jack on the board (Power Supply Unit (PSU) in [Figure 3](#), JP13 jumper description in [Table 2](#)).
- 5V DC power with 500mA limitation from CN13, the ST-LINK/V2 type-B USB connector (STIk in [Figure 3](#), JP13 jumper description in [Table 2](#)).
- 5V DC power from both CN8 and CN9, the extension connector for daughterboard (DTB for Daughterboard in [Figure 3](#), JP13 jumper description in [Table 2](#)).

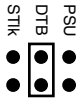
The power supply is configured by setting the related jumpers JP13, JP1 and JP10 as described in [Table 2](#).

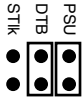
Table 2. Power related jumpers

Jumper	Description	Jumper setting
JP13 (selects one of the three possible power supply resources)	For power supply jack (CN14) to the STM32100E-EVAL <u>only</u> , JP13 is set as shown to the right:	
	For power supply from the daughterboard connectors (CN8 and CN9) to STM32100E-EVAL <u>only</u> , JP13 is set as shown to the right:	
	For power supply from ST-LINK/V2 USB connector (CN13) to STM32100E-EVAL <u>only</u> , JP13 is set as shown to the right: (Default setting)	
	For power supply from power supply jack (CN14) to <u>both</u> STM32100E-EVAL and daughterboard connected on CN8 and CN9, JP13 is set as shown to the right: (daughter board must have not its own powersupply connected)	
JP1	Vbat is connected to +3.3V power when JP1 is set as shown to the right: (Default setting)	
	Vbat is connected to battery when JP1 is set as shown to the right:	
JP10	Enables consumption measurements of both VDD and VDDA. Default setting: Fitted	

Danger: RISK OF EXPLOSION IF BATTERY IS REPLACED BY AN INCORRECT TYPE. DISPOSE OF USED BATTERIES ACCORDING TO THE INSTRUCTIONS.

The LED LD6 is lit when the STM32100E-EVAL evaluation board is powered by the 5 V correctly.

Note: The recommended AC220V to DC5V power adapter is the PSU-5V2A. It is not included with the board but can be ordered from ST as a separate item. You can also use another equivalent 5V power adapter (polarity compatible with CN14) to power STM32100E-EVAL board via the CN14 power jack on the board. To order the recommended power supply, use the order code: PSU-5V2A.

2.3 Boot option

The STM32100E-EVAL evaluation board is able to boot from:

- Embedded user Flash
- System memory with boot loader for ISP
- Embedded SRAM for debugging

The boot option is configured by setting switch SW1 and SW2.

Table 3. Boot related switches and jumper

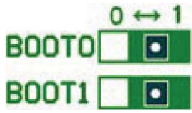
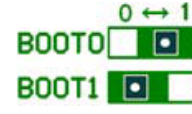
Switch	Boot source	Switch configuration
SW1 SW2	STM32100E-EVAL boot from User Flash when BOOT0 is set as shown to the right: BOOT1 is don't care in this configuration. (Default setting)	
	STM32100E-EVAL boot from Embedded SRAM when BOOT0 and BOOT1 are set as shown to the right:	
	STM32100E-EVAL boot from System Memory when BOOT0 and BOOT1 are set as shown to the right:	
JP8	The BOOT0 pin of STM32F100ZET6 is connected to RS-232 connector CN10 pin 6 (DSR) for ISP support when JP8 is closed. This configuration is used for bootloader application only. (Default Setting: Not fitted)	

2.4 Clock source

Two clock sources are available on STM32100E-EVAL evaluation board for STM32F100ZET6 microcontroller:

- X2, 32 kHz crystal for embedded RTC
- X1, 8 MHz Crystal with socket for STM32F100ZET6 Microcontroller, it can be removed from its socket when internal RC clock is used.

Table 4. RTC related solder bridges

Solder bridge	Description
SB5, SB6	PC14 and PC15 are connected to extension connector CN8 when solder bridges SB5 and SB6 are closed. Default Setting: Not fitted

2.5 Reset source

The reset signal of STM32100E-EVAL evaluation board is active low and the reset sources include:

- Reset button B1
- Debugging tools from JTAG connector CN7
- Daughterboard from CN9
- Embedded ST-LINK/V2
- Bootloader_Reset from RS-232 connector CN10

Table 5. Reset related jumpers

Jumper	Description
JP7	Bootloader_Reset signal from RS-232 connector CN10 pin 1 (DCD) is connected to RESET# of STM32F100ZET6 when JP7 is closed. This configuration is used for bootloader application only. Default Setting: Not fitted.

2.6 Audio

STM32100E-EVAL evaluation board supports playback based on a speaker on the board. Two channels DAC of STM32F100ZET6 are connected to audio amplifier TS4956EIJT which drive both speaker and stereo audio jack output. The audio volume can be adjusted by configuration of audio amplifier through I²C interface.

Table 6. Audio related jumpers

Jumper	Description
JP15	The I/O pin PA5 is connected to Audio DAC as DAC2 when JP15 is closed. JP15 must be kept open for connection to serial flash as Flash_SCK. Default setting: Not fitted

Note: Channel DAC1 is shared by audio and BNC while channel DAC2 is shared by audio and serial Flash on the board.

2.7 EEPROM

The EEPROM M24C64-WMN6TP connected to I2C2 of STM32F100ZET6 is available on the board. Its address can be changed by setting solder bridge SB10.

Table 7. EEPROM related jumper and solder bridge

Jumper	Description
JP14	The EEPROM write operations are disabled when JP14 is open. Default Setting: Fitted
SB10	The device address of EEPROM is 0xA0 when SB10 is open and 0xA2 when SB10 is closed. Default Setting: Not fitted

2.8 IrDA

IrDA communication is supported by IrDA transceiver U16 connected to USART4 of STM32F100ZET6. IrDA can be enabled or disabled by setting PA11.

2.9 Motor control

The STM32100E-EVAL evaluation board supports an induction motor control via a 34-pin connector. Connector CN1 provides all required control and feedback signals to and from the motor power driving board. Available signals on this connector include emergency stop, motor speed, 3-phase motor current, bus voltage, heatsink temperature coming from the motor driving board and 6 channels of PWM control signal going to the motor driving circuit.

Special motor current sampling operation is enabled by setting jumper JP12.

Table 8. Motor control related jumpers

Jumper	Description	Jumper setting						
JP12	The special motor current sampling operation is enabled when JP12 is fitted (PD2 connected to PB4). The I/O pins PD2 and PB4 are disconnected and can be used by daughterboard when JP12 is NOT fitted. Default setting: Not fitted							
JP2	JP2 must be open when encoder signal is from pin 31 of motor control connector CN1. JP2 must be closed when the analog signal is from pin31 of CN1 for special motor. Default setting: Not fitted							
JP3	PA6 is connected to motor control connector CN1 as MC_EmergencySTOP when JP3 is closed. JP3 must be kept on open for serial Flash operation. Default setting: Not fitted							
JP4	PA0 is connected to RS-232 transceiver U5 as USART2_CTS when JP4 is set as shown to the right: (Default setting)	<table style="border-collapse: collapse; margin: auto;"> <tr> <td style="padding: 0 5px;">1</td> <td style="padding: 0 5px;">2</td> <td style="padding: 0 5px;">3</td> </tr> <tr> <td style="text-align: center;">●</td> <td style="text-align: center;">●</td> <td style="text-align: center;">●</td> </tr> </table>	1	2	3	●	●	●
	1	2	3					
●	●	●						
PA0 is connected to motor control connector CN1 as MC_EnA when JP4 is set as shown to the right:	<table style="border-collapse: collapse; margin: auto;"> <tr> <td style="padding: 0 5px;">1</td> <td style="padding: 0 5px;">2</td> <td style="padding: 0 5px;">3</td> </tr> <tr> <td style="text-align: center;">●</td> <td style="text-align: center;">●</td> <td style="text-align: center;">●</td> </tr> </table>	1	2	3	●	●	●	
1	2	3						
●	●	●						
JP5	PA10 is connected to motor control connector CN1 as MC_WH when JP5 is set as shown to the right:	<table style="border-collapse: collapse; margin: auto;"> <tr> <td style="padding: 0 5px;">1</td> <td style="padding: 0 5px;">2</td> <td style="padding: 0 5px;">3</td> </tr> <tr> <td style="text-align: center;">●</td> <td style="text-align: center;">●</td> <td style="text-align: center;">●</td> </tr> </table>	1	2	3	●	●	●
	1	2	3					
●	●	●						
PA10 is connected to USART1_RX when JP4 JP5 is set as shown to the right: (Default setting)	<table style="border-collapse: collapse; margin: auto;"> <tr> <td style="padding: 0 5px;">1</td> <td style="padding: 0 5px;">2</td> <td style="padding: 0 5px;">3</td> </tr> <tr> <td style="text-align: center;">●</td> <td style="text-align: center;">●</td> <td style="text-align: center;">●</td> </tr> </table>	1	2	3	●	●	●	
1	2	3						
●	●	●						
JP9	PD2 is used as MC_PFCsync2 output on motor control connector CN1 when JP9 is open. PD2 is used as USART5_RX input when JP9 is closed. Default setting: Fitted							
JP11	PB12 is used as MC_NTC on motor control connector CN1 when JP11 is open. PB12 is used as temperature interrupt input when JP11 is closed. JP11 must be kept closed for TemperatureSensor_INT operation. Default setting: Fitted							

2.10 MicroSD card

The 1 Gbyte (or more) MicroSD card connected to SPI2 of STM32F100ZET6 is available on the board. MicroSD card chip select is managed by standard I/O port PG6 while MicroSD card detect signal is managed by I/O port PF11.

2.11 Analog input

One BNC connector CN4 is connected to PA4 of STM32F100ZET6 as external analog input or DAC output. The 50 ohm terminal resistor can be enabled by closing of solder bridge SB2. A low pass filter can be implemented for BNC connector by replacing of R49 and C45 by ADC input or replacing R48 and C45 for DAC output with the right value of the resistor and capacitor as presented in the end user's application.

There are also 2 analog signals available on the board:

- 10K ohm potentiometer RV1 connected to PC4.
- External ADC input which can be connected to TP1 (AIN+) and TP2 (AIN-), R51 should be removed to avoid noise.

2.12 SRAM

The 2 Mbyte SRAM (IS61WV102416BLL-10MLI) is connected to Bank 2 of FSMC of STM32F100ZET6 on the board.

2.13 Serial Flash

A 128 Mbit serial Flash memory connected to SPI1 of STM32F100ZET6, serial Flash chip select is managed by standard I/O port PE6.

Note: JP3 must be kept open for serial Flash operation. Please refer to [Table 8](#) for details.

2.14 Temperature sensor

One I2C interface temperature sensor STLM75 (–55°C to +125°C) connected to I2C2 of STM32F100ZET6 is available on the board. Its address can be changed by setting of solder bridge SB8.

Table 9. Temperature Sensor Related Solder bridges

Jumper	Description
SB8	Temperature sensor device address is 0x90 when SB8 is open and 0x92 when SB8 is closed. Default Setting: Not fitted

Note: JP11 must be closed for temperatureSensor_INT operation. Please refer to [Table 8](#) for details.

2.15 Display and input devices

The 3.2" TFT color LCD connected to Bank 3 (FSMC) of STM32F100ZET6 and 4 general purpose LEDs (LD1,2,3,4) are available as display devices. The touch screen is supported on the TFT LCD by I/O port expander STMPE811QTR which is connected via I2C bus to the microcontroller. A 4-direction joystick with selection key, general purpose button (B4), wakeup button (B2) and tamper detection button (B3) are available as input devices.



Table 10. Touch screen related solder bridge and jumper

Jumper	Description
SB9	The device address of I/O expander U19 is 0x82 when SB9 is open and 0x88 when SB9 is closed. Default Setting: Not fitted

2.16 HDMI CEC

Two HDMI connectors CN2 and CN3 are available on STM32100E-EVAL board. The signals CEC, SCL, SDA and HPD are supported and connected to STM32F100ZET6 through HDMI2C1-5DIJ, the ST full integrated ESD protection, level-shifting device and signal booster for control links of HDMI 1.3 transmitter.

Table 11. HDMI CEC Related solder bridge and jumper

Jumper	Description	Jumper setting
SB1	The +5V power pin of HDMI connectors CN2 and CN3 is connected to 5V power on STM32100E-EVAL board when SB1 is closed. Default Status: Open	
JP6	PB7 is connected to HDMI level shifter U2 as I2C1_SDA when JP6 is set as shown to the right: (Default setting)	
	Configuration not used:	

2.17 IR receiver

The IR receiver TSOP34836 is connected to PC6 of STM32F100ZET6 on the board.

2.18 RS-232 communication

Two D-type 9-pin connectors are available on STM32100E-EVAL evaluation board:

- CN10 (USART1) connector is connected to RS-232 transceiver U7 with Bootloader_Reset and Bootloader_BOOT0 support for ISP
- CN5 (USART2) connector with RTS/CTS handshake signal support is connected to RS-232 transceiver U5

Note: Jumper JP4 must be fitted on pins 2-3 for USART2 operations and jumper JP5 must be fitted on pins 1-2 for USART1 operations. Please refer to [Table 8](#) for more details.

2.19 RS-485 communication

The RS-485 communication on USART5 is supported by RS-485 transceiver ST485ABDR and connected to pin4 and pin 9 of D-type 9-pin connector CN10 (shared with USART1).

Table 12. RS-485 related solder bridges

Solder bridge	Description
SB3, SB4	The external fail-safe biasing are enabled when solder bridges SB3 and SB4 are closed. Default Setting: Not fitted
SB7	The bus termination is enabled when solder bridge SB7 is closed. Default Setting: Not fitted

Note: Jumper JP9 must be fitted for RS-485 operations. Please refer to [Table 8](#) for more details.

3 Connectors

3.1 Motor control connector CN1

Figure 4. Motor control connector CN1

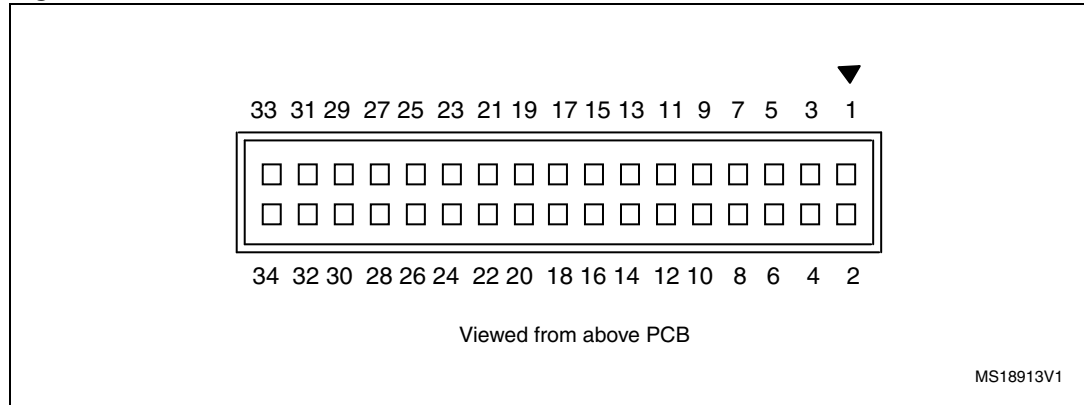

Table 13. Motor control connector CN1 pin assignments

Description	Pin of STM32F100 ZET6	Pin number of CN1	Pin number of CN1	Pin of STM32F100 ZET6	Description
EMERGENCY STOP	PA6	1	2		GND
PWM-UH	PA8	3	4		GND
PWM-UL	PA7	5	6		GND
PWM-VH	PA9	7	8		GND
PWM-VL	PB0	9	10		GND
PWM-WH	PA10	11	12		GND
PWM-WL	PB1	13	14	PC0	BUS VOLTAGE
PHASE A CURRENT	PC1	15	16		GND
PHASE B CURRENT	PC2	17	18		GND
PHASE C CURRENT	PC3	19	20		GND
NTC BYPASS RELAY	PB12	21	22		GND
DISSIPATIVE BRAKE PWM	PC8	23	24		GND
+5 V power		25	26	PC5	Heatsink temperature
PFC SYNC	PD2 and PB4	27	28		3.3V power (VDD MCU)
PFC PWM	PB5	29	30		GND
Encoder A	PA0	31	32		GND
Encoder B	PA1	33	34	PA2	Encoder Index

3.2 HDMI connectors CN2 and CN3

Figure 5. HDMI connectors CN2 & CN3

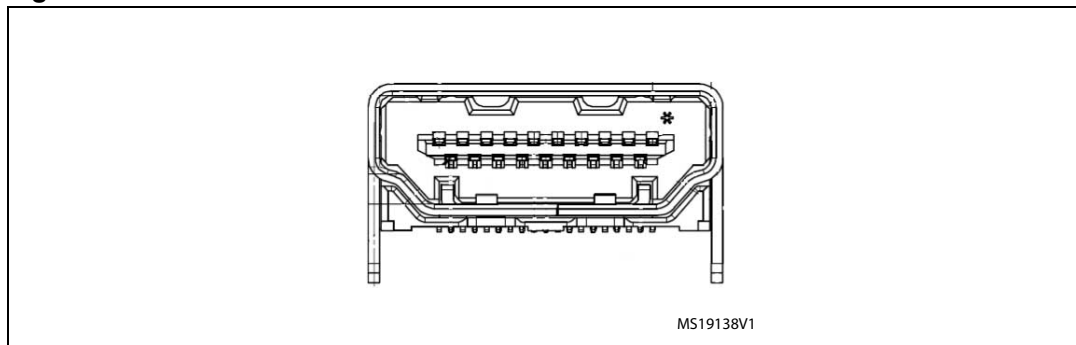

Table 14. HDMI connectors CN2 & CN3

Pin number	Description	Pin number	Description
1-12	NC	16	SDA (PB7)
13	CEC (PB8)	17	GND
14	NC	18	NC
15	SCL (PB6)	19	HPD (PB9)

3.3 Analog input connector CN4

Figure 6. Analog input connector CN4

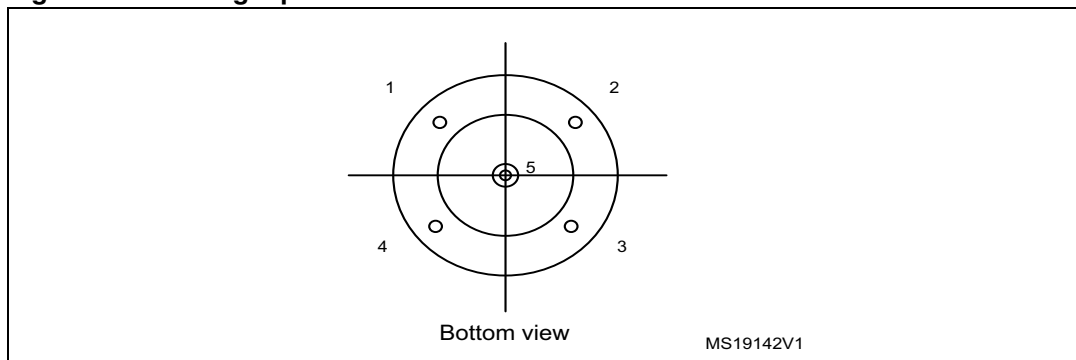

Table 15. HDMI connectors CN2 & CN3

Pin number	Description	Pin number	Description
1	GND	4	GND
2	GND	5	Analog input/PA4
3	GND		

3.4 RS-232 connector CN5 with RTS/CTS handshake support

Figure 7. RS-232 connector CN5 with RTS/CTS handshake support

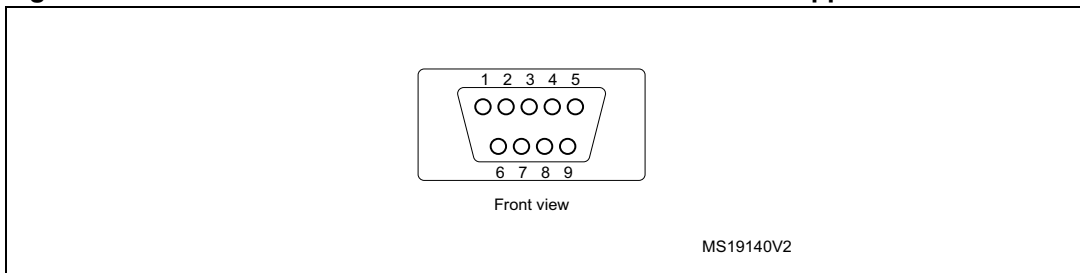

Table 16. RS-232 connector CN5 with full modem control support

Pin number	Description	Pin number	Description
1	NC	6	Connect to Pin 4
2	USART2_RX	7	USART2_RTS
3	USART2_TX	8	USART2_CTS
4	Connect to Pin 6	9	NC
5	GND		

3.5 RS-232 with ISP support and RS-485 connector CN10

Figure 8. RS-232 with ISP support and RS-485 connector CN10

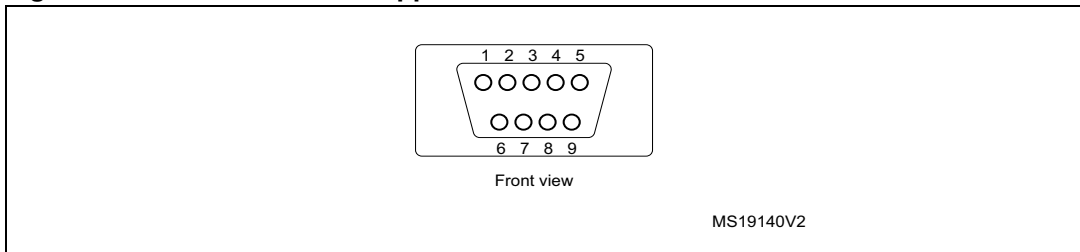

Table 17. RS-232/RS-485 connector CN10

Pin number	Description	Pin number	Description
1	NC	6	BOOTLOADER_BOOT0
2	USART1_RX	7	NC
3	USART1_TX	8	BOOTLOADER_RESET
4	RS485_A	9	RS485_B
5	GND		

3.6 MicroSD connector CN6

Figure 9. MicroSD connector CN6

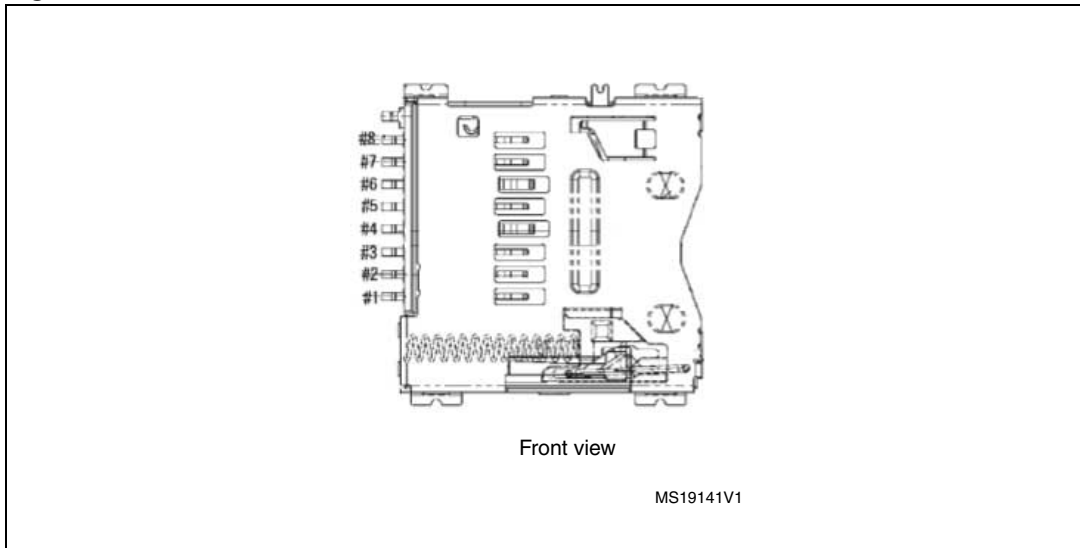

Table 18. MicroSD connector CN6

Pin number	Description	Pin number	Description
1	Reserved	5	SCLK/PB13
2	CS/PG6	6	Vss/GND
3	DI/PB15	7	DO/PB14
4	VDD	10	Card Detect (PF11)

3.7 JTAG debugging connector CN7

Figure 10. JTAG debugging connector CN7

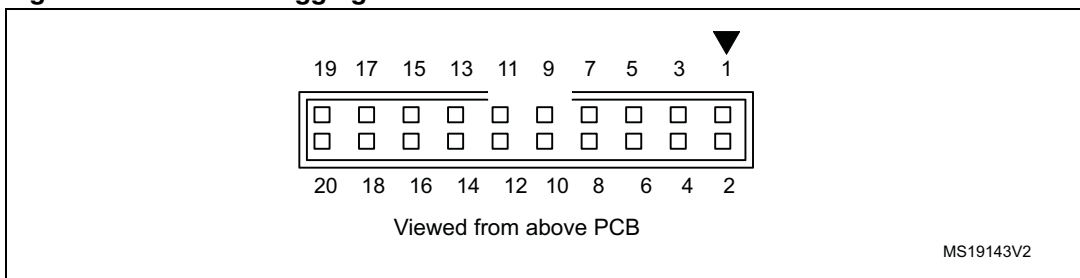

Table 19. JTAG debugging connector CN7

Pin number	Description	Pin number	Description
1	3.3V power	2	3.3V power
3	TRST	4	GND
5	TDI	6	GND

Table 19. JTAG debugging connector CN7 (continued)

Pin number	Description	Pin number	Description
7	TMS/SWDIO	8	GND
9	TCK/SWCLK	10	GND
11	RTCK	12	GND
13	TDO/SWO	14	GND
15	RESET#	16	GND
17	Pull-Down	18	GND
19	Pull-Down	20	GND

3.8 Daughterboard extension connectors CN8 and CN9

Two 70-pinmale header connectors CN8 and CN9 can be used to connect with daughterboard or standard wrapping board to STM32100E-EVAL evaluation board. All GPI/Os are available on it. The space between these two connectors and position of power, GND and RESET pins are defined as a standard which allows to develop common daughterboards for several evaluations boards.

The standard width between CN8 pin1 and CN9 pin1 is 2700 mils (68.58mm). The standard was implemented on the majority of evaluation boards. Each pin on CN8 and CN9 can be used by a daughterboard after disconnecting it from the corresponding function block on STM32100E-EVAL evaluation board. Please refer to [Table 20](#) and [Table 21](#) for more details. The shading in these tables corresponds to the power pins.

Table 20. Daughterboard extension connector CN8

Pin	Description	Alternative function	How to disconnect from function block on STM3210E-EVAL board
1	GND	-	-
3	PC7	LCD_backlight	-
5	PC9	RS485_DIR	-
7	PA9	MC_VH	Disconnect STM3210E-EVAL evaluation board from motor.
9	PA0	MC/Wakeup/ USART2_CTS	Keep JP4 on open
11	-	-	-
13	PA12	IO_Expandor_INT	Remove R99
15	PA14	Debug_TCK	-
17	PC10	IrDA_TX	-
19	GND	-	-
21	PD0	FSMC_D2	-
23	PE2	-	-

Table 20. Daughterboard extension connector CN8 (continued)

Pin	Description	Alternative function	How to disconnect from function block on STM3210E-EVAL board
25	PD2	MC/RS485	Disconnect STM3210E-EVAL evaluation board from motor power drive board. Keep JP9 on open.
27	PD4	FSMC_NOE	-
29	PD6	FSMC_MWAIT	Remove R36
31	PD7	FSMC_NE0	Remove R22
33	PG10	FSMC_NE2	Remove R18
35	PG12	FSMC_NE3	Remove R85
37	PG14	Joystick_Left	Remove R106
39	GND	-	-
41	PB4	Debug_TRST/MC	Disconnect STM3210E-EVAL evaluation board from motor power drive board or remove JP12.
43	PB6	I2C1_SCL	Remove R38
45	PB8	HDMI_CEC	Remove R37
47	PE0	FSMC_BLN0	-
49	D5V	-	-
51	PE4	FSMC_A20	-
53	PE6	Flash_CS	Remove R44
55	PC14	OSC32_IN	Remove R59. Keep solder bridge SB5 on close.
57	PF0	FSMC_A0	-
59	GND	-	-
61	PF2	FSMC_A2	-
63	PF4	FSMC_A4	-
65	PF6	LD1	Remove R76
67	PF8	LD3	Remove R74
69	+3V3	-	-
2	PC6	IR_receiver	Remove R1
4	PC8	MC	Disconnect STM3210E-EVAL evaluation board from motor power drive board.
6	PA8	MCO/MC_UH	-
8	PA10	USART1_RX/MC_WH	Keep JP5 on open
10	GND	-	-
12	PA11	IrDA_SD	-
14	PA13	Debug TMS	-

Table 20. Daughterboard extension connector CN8 (continued)

Pin	Description	Alternative function	How to disconnect from function block on STM3210E-EVAL board
16	PA15	Debug TDI	-
18	PC11	IrDA_RX	Remove R110
20	PC12	RS485_TX	-
22	PD1	FSMC_D3	-
24	PE1	FSMC_BLN1	-
26	PD3	FSMC_CLK	-
28	PD5	FSMC_WEN	-
30	GND	-	-
32	PG9	-	-
34	PG11	Joystick_Down	Remove R104
36	PG13	Joystick_Right	Remove R107
38	PG15	Joystick_Up	Remove R108
40	PB3	Debug_TDO	-
42	PB5	MC	Disconnect STM3210E-EVAL evaluation board from motor power drive board.
44	PB7	FSMC/I2C1	Keep JP6 on open
46	PB9	HDMI_HPD	Remove R35
48	3V3	-	-
50	GND	-	-
52	PE3	FSMC_A19	-
54	PE5	-	-
56	PC13	Anti-tamper button	Remove R103
58	PC15	OSC32_OUT	Remove R60. Keep solder bridge SB6 on close.
60	PF1	FSMC_A1	-
62	PF3	FSMC_A3	-
64	PF5	FSMC_A5	-
66	PF7	LD2	Remove R75
68	PF9	LD4	Remove R73
70	GND	-	-

Table 21. Daughterboard extension connector CN9

Pin	Description	Alternative function	How to disconnect from function block on STM3210E-EVAL board
1	GND	-	-
3	PG7	Joystick_Select	Remove R105
5	PG5	FSMC_A15	-
7	PG3	FSMC_A13	-
9	PC13 Button B3	-	-
11	RESET#	-	-
13	PD12	FSMC_A17	Remove R99
15	PD10	FSMC_D15	-
17	PC8	FSMC_D13	-
19	D5V	-	-
21	PB13	MicroSDcard	-
23	PB11	I2C2_SDA	Remove R72
25	PE15	FSMC_D12	-
27	PE13	FSMC_D10	-
29	PE11	FSMC_D8	-
31	PD15	FSMC_D1	-
33	PE9	FSMC_D6	-
35	PE7	FSMC_D4	-
37	PG1	FSMC_A11	-
39	GND	-	-
41	PF14	FSMC_A8	Disconnect STM3210E-EVAL evaluation board from motor power drive board or remove JP12.
43	PF12	FSMC_A6	-
45	PB2	BOOT1	Remove R37
47	PB1	MC	Disconnect STM3210E-EVAL evaluation board from motor power drive board.
49	-	-	-
51	PB0	MC	Disconnect STM3210E-EVAL evaluation board from motor power drive board.-
53	PC4	Potentiometer	Remove R47
55	PA6	MC/SPI_MISO	Disconnect STM3210E-EVAL evaluation board from motor power drive board. Remove R46.
57	PA4	BNC/DAC_audio	-

Table 21. Daughterboard extension connector CN9 (continued)

Pin	Description	Alternative function	How to disconnect from function block on STM3210E-EVAL board
59	GND	-	-
61	PA1	MC/USART2_RTS	Disconnect STM3210E-EVAL evaluation board from motor power drive board.
63	PC3	MC	Disconnect STM3210E-EVAL evaluation board from motor power drive board.
65	PC1	MC	Disconnect STM3210E-EVAL evaluation board from motor power drive board.
67	PF10	-	-
69	+3V3	-	-
2	PG8	User button B4	Remove R109
4	PG6	MicroSDcard_CS	Remove R16
6	PG4	FSMC_A14	-
8	PG2	FSMC_A12	-
10	GND	-	-
12	PD13	FSMC_A18	-
14	PD11	FSMC_A16	-
16	PD9	FSMC_A14	-
18	PB15	MicroSD card	-
20	PB14	MicroSD card	Remove R24
22	PB12	MC/Temperature Sensor	Disconnect STM3210E-EVAL evaluation board from motor power drive board. Keep JP11 on open
24	PB10	I2C2_SCK	Remove R77
26	PE14	FSMC_D11	-
28	PE12	FSMC_D9	-
30	GND	-	-
32	PD14	FSMC_D0	-
34	PE10	FSMC_D7	-
36	PE8	FSMC_D5	-
38	-	-	-
40	PG0	FSMC_A10	-
42	PF15	FSMC_A9	-
44	PF13	FSMC_A7	-
46	PF11	MicroSD card detection	Remove SD card from card socket CN6
48	-	-	-
50	GND	-	-

Table 21. Daughterboard extension connector CN9 (continued)

Pin	Description	Alternative function	How to disconnect from function block on STM3210E-EVAL board
52	PC5	MC	Disconnect STM3210E-EVAL evaluation board from motor power drive board.
54	PA7	MC/SPI_MOSI	Disconnect STM3210E-EVAL evaluation board from motor power drive board.
56	PA5	SPI_CLK/DAC_audio	-
58	PA3	USART2_RX	Remove R138
60	PA2	MC/USART2_TX	Disconnect STM3210E-EVAL evaluation board from motor power drive board.
62	-	-	-
64	PC2	MC	Disconnect STM3210E-EVAL evaluation board from motor power drive board.
66	PC0	MC	Disconnect STM3210E-EVAL evaluation board from motor power drive board. Remove R9 and C12.
68	-	-	-
70	GND	-	-

3.9 Audio jack CN11

A 3.5mm Mono audio jack connector CN11 is available on STM32100E-EVAL board. The speaker U12 will be bypassed when an earphone is plugged into connector CN11.

3.10 ST-LINK/V2 connector CN13 (USB connector)

Figure 11. ST-LINK/V2 USB connector CN13 (viewed from front)

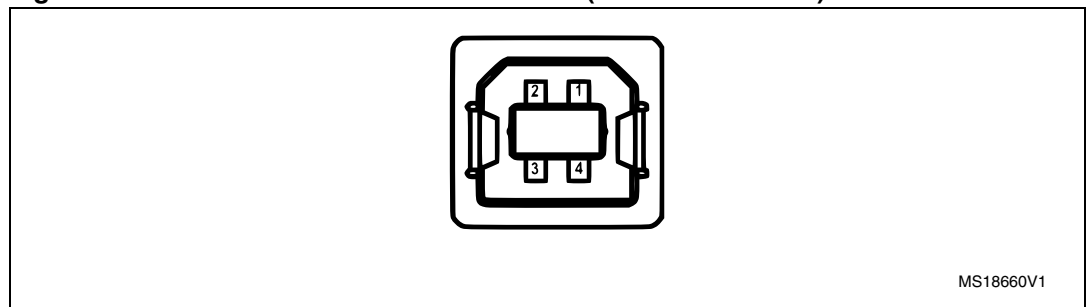

Table 22. ST-LINK/V2 USB connector CN13

Pin number	Description	Pin number	Description
1	VBUS(power)	4	GND
2	DM	5	Shield
3	DP	6	

3.11 ST-LINK/V2 programming connector CN12 (reserved connector)

The connector CN12 is not mounted on the board and reserved for manufacture only.

3.12 Power connector CN14

The STM32100E-EVAL evaluation board can be powered by a DC 5V power supply via the external power supply jack connector CN14 shown in [Figure 12](#). The central pin of CN14 must be positive.

Figure 12. Power supply connector CN14

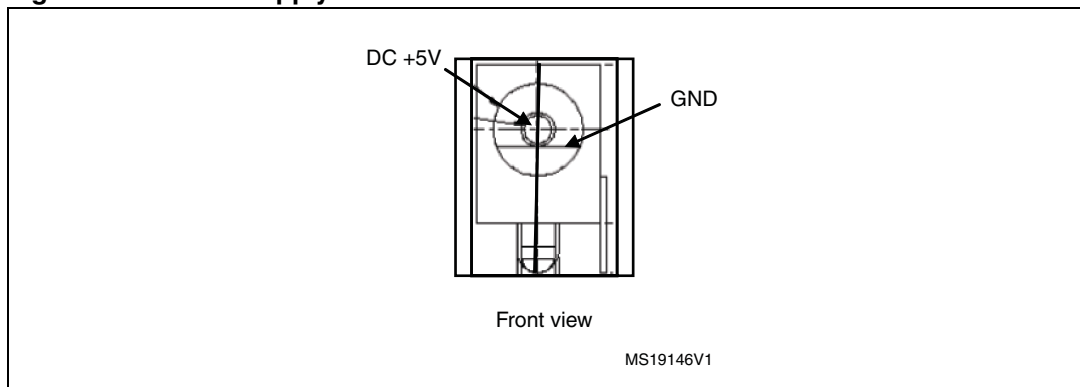

4 Schematics

The following schematics are listed:

- [Figure 13: Schematic diagram of STM32100E-EVAL on page 28](#)
- [Figure 14: STM32100E-EVAL MCU on page 29](#)
- [Figure 15: STM32100E-EVAL SRAM and OneNAND on page 30](#)
- [Figure 16: STM32100E-EVAL LCD, EEPROM and TSensor on page 31](#)
- [Figure 17: STM32100E-EVAL Audio schematic on page 32](#)
- [Figure 18: STM32100E-EVAL I/O Peripherals on page 33](#)
- [Figure 19: STM32100E-EVAL MicroSD and SPI Flash on page 34](#)
- [Figure 20: STM32100E-EVAL RS-485, RS-232 and IrDA on page 35](#)
- [Figure 21: STM32100E-EVAL HDMI_CEC and IR receiver on page 36](#)
- [Figure 22: STM32100E-EVAL JTAG on page 37](#)
- [Figure 23: STM32100E-EVAL ST-LINK \(JTAG only\) on page 38](#)
- [Figure 24: STM32100E-EVAL motor control on page 39](#)
- [Figure 25: STM32100E-EVAL power on page 40](#)
- [Figure 26: STM32100E-EVAL \(MB785\) 3.2" LCD module with both SPI and 16 bit interface on page 41](#)

Figure 13. Schematic diagram of STM32100E-EVAL



Figure 14. STM32100E-EVAL MCU

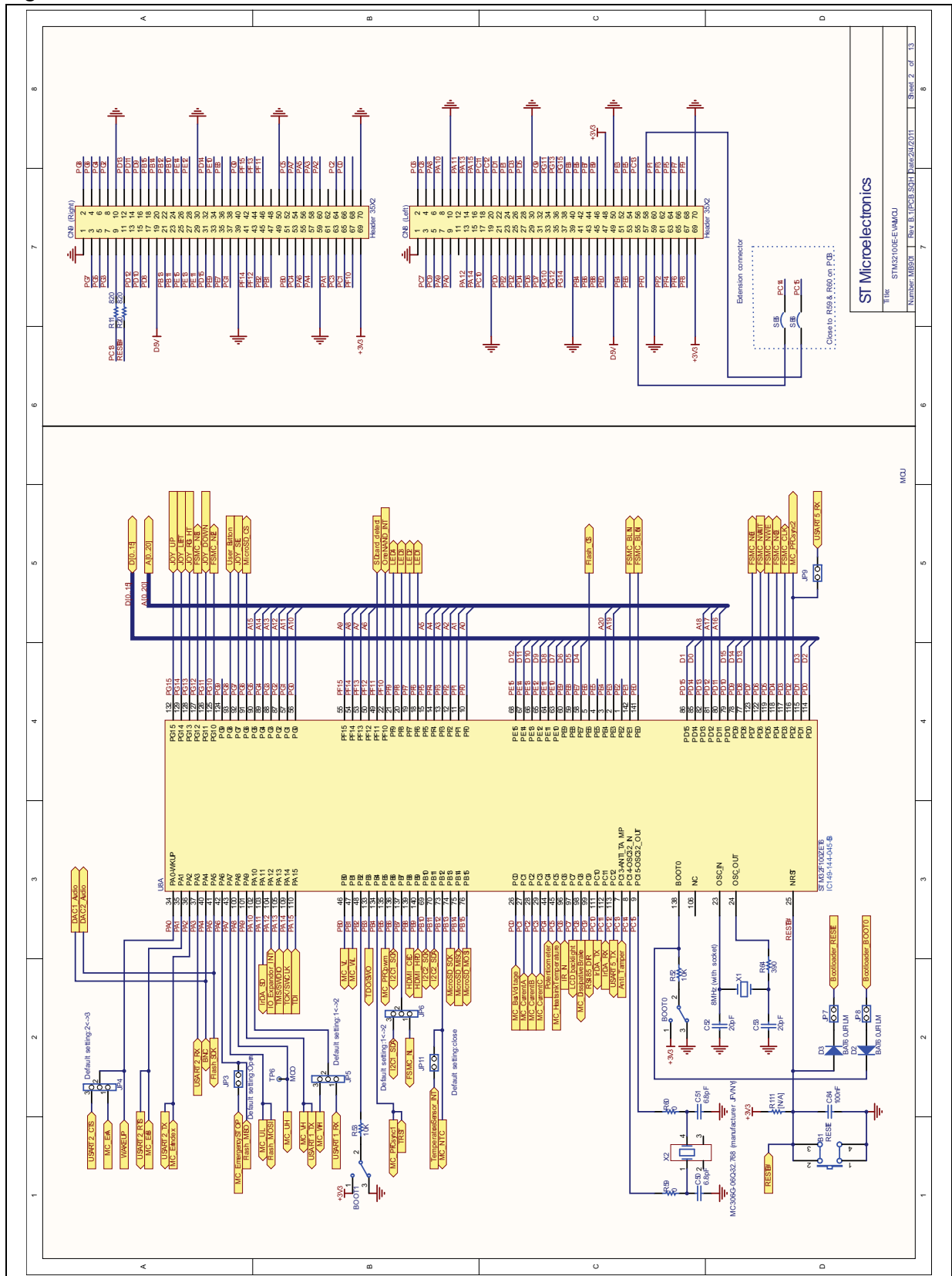
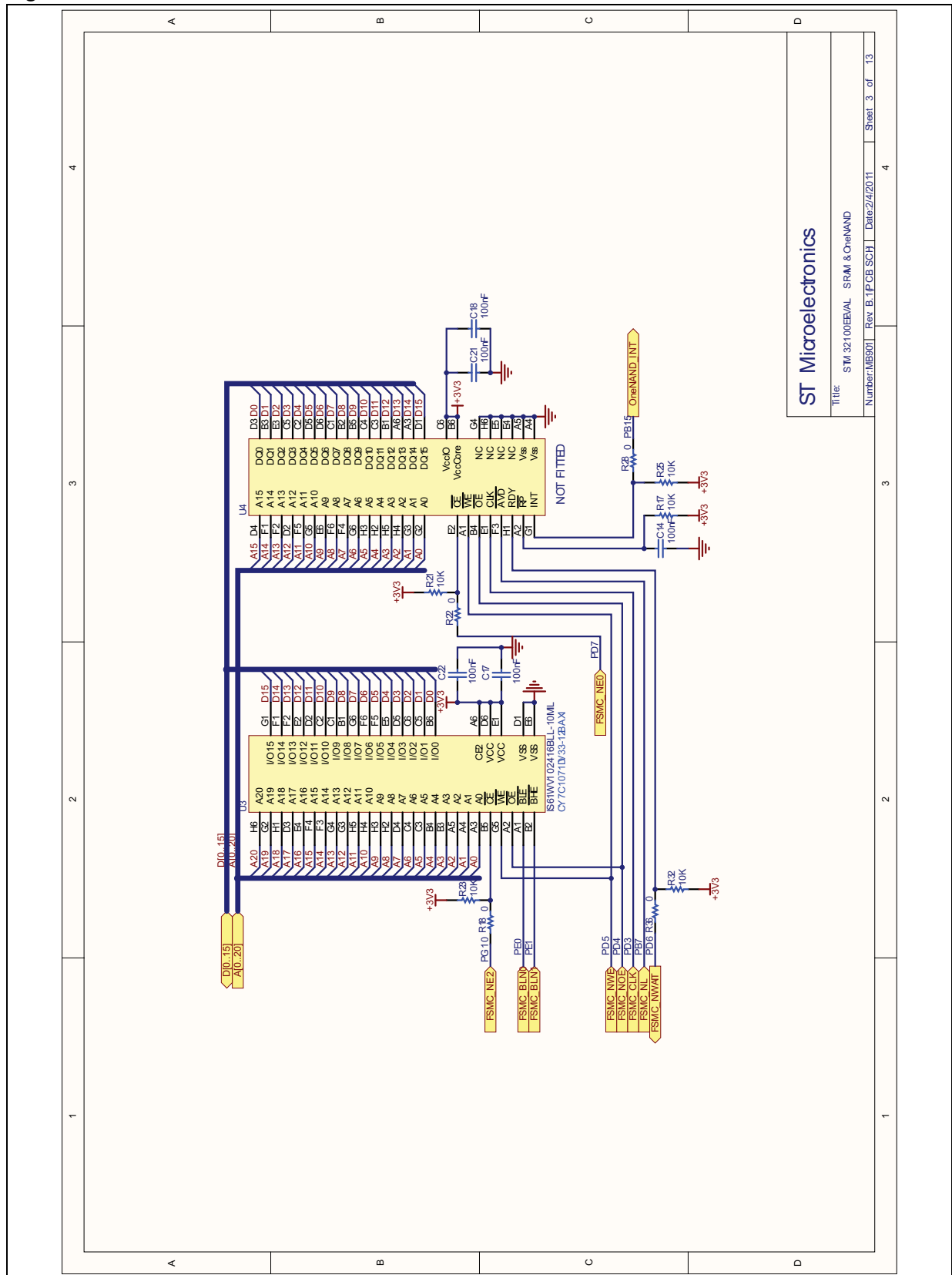

Figure 15. STM32100E-EVAL SRAM and OneNAND



ST Microelectronics

Title: STM32100EVAL SRAM & OneNAND
 Number: MB901 Rev. B.1 PCB SCH | Date: 24/2011 | Sheet 3 of 13

Figure 16. STM32100E-EVAL LCD, EEPROM and TSensor

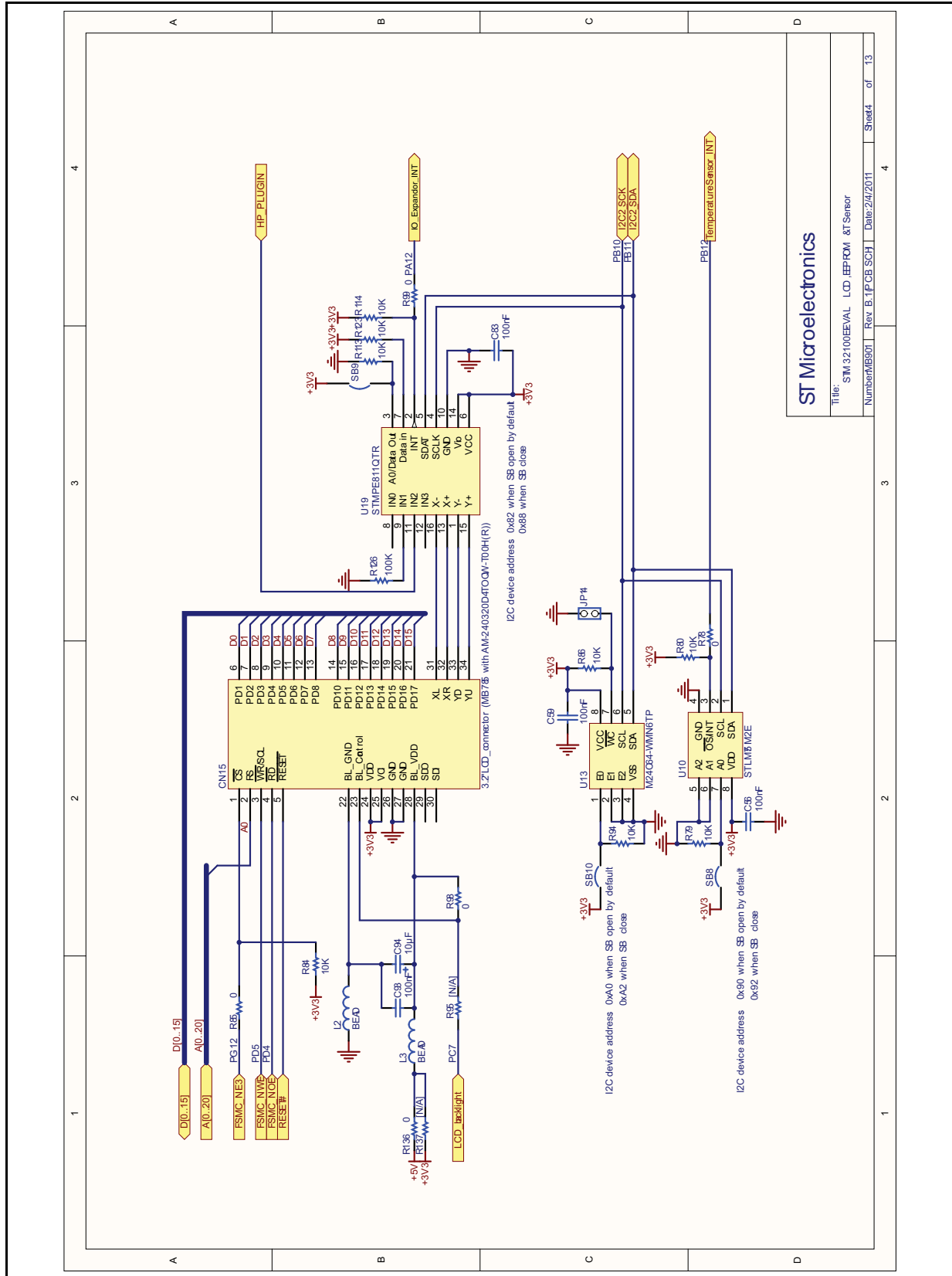

ST Microelectronics

Title: STM32100EVAL LCD EEPROM &T Sensor
 Number:MB901 | Rev.B.1|PCB SCH | Date:2/4/2011 | Sheet4 of 13

Figure 17. STM32100E-EVAL Audio schematic

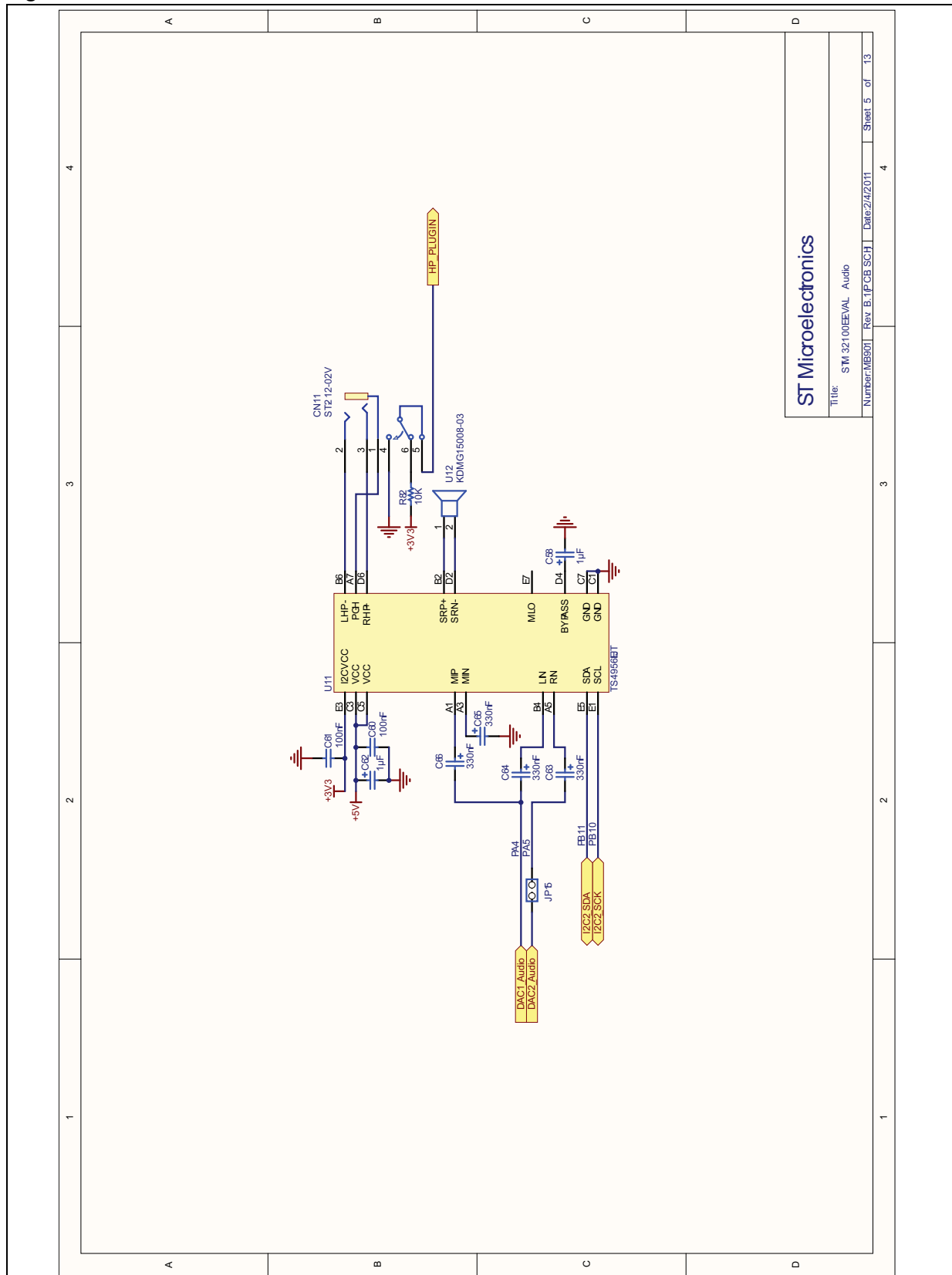
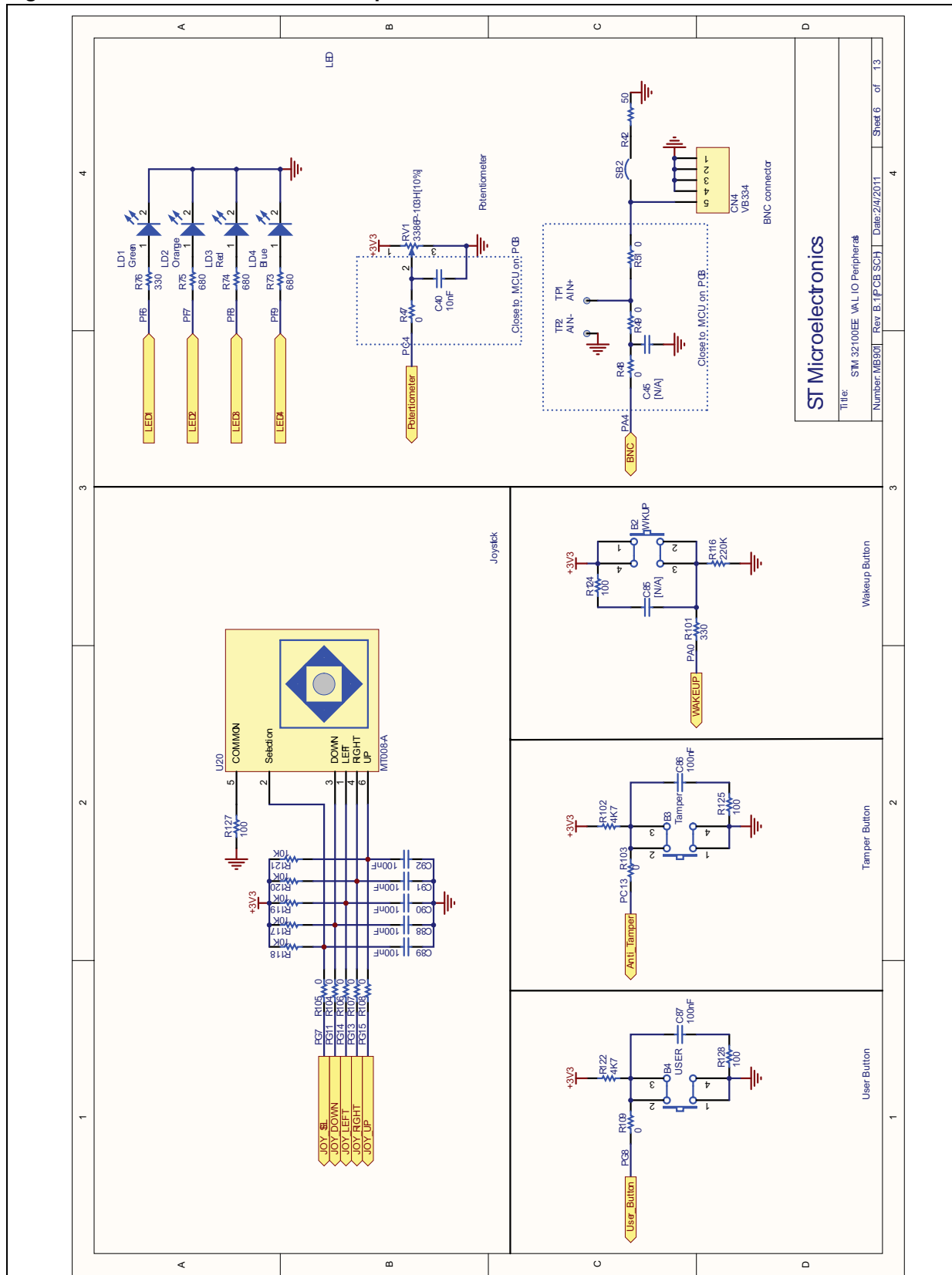
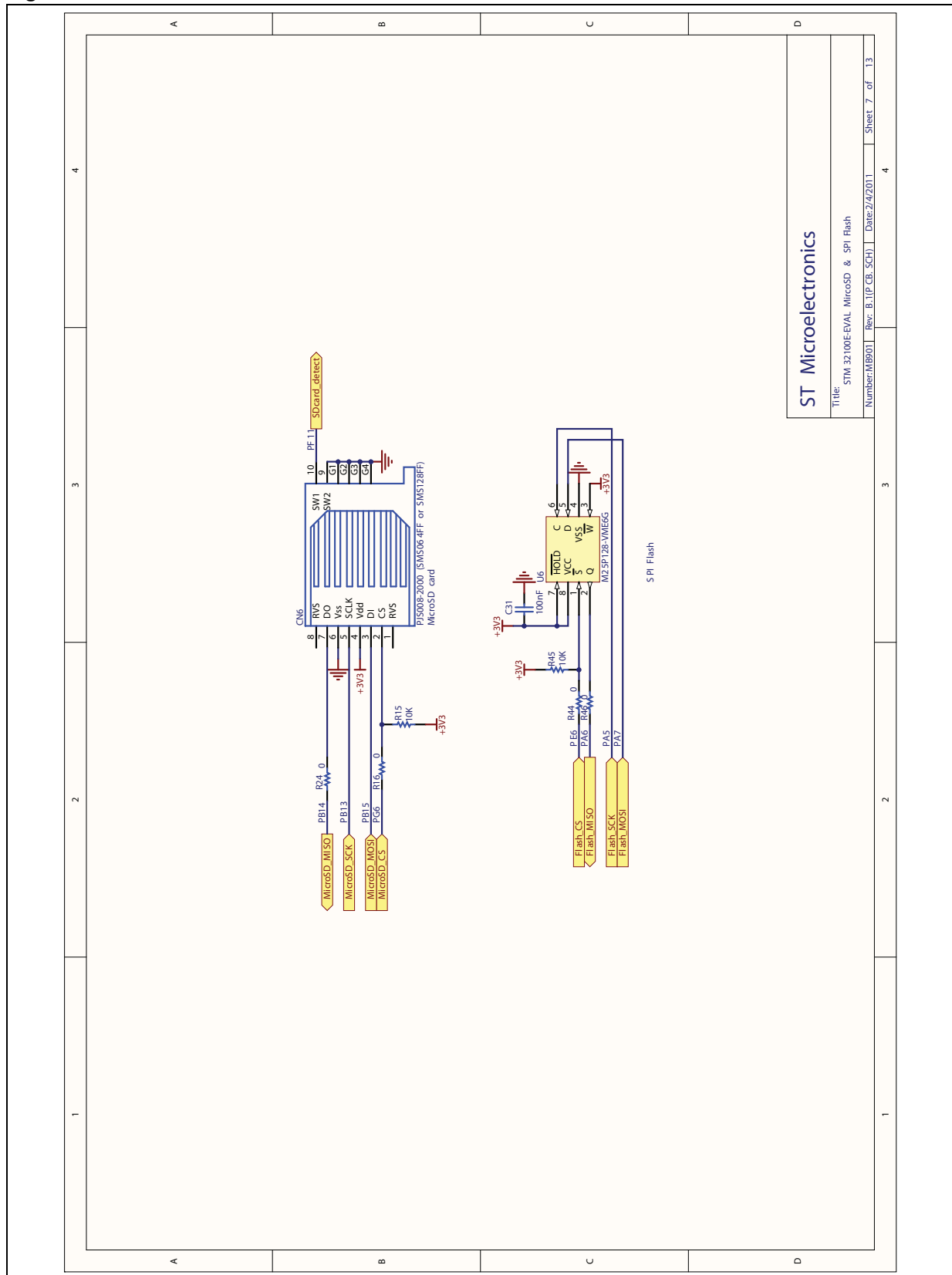

Figure 18. STM32100E-EVAL I/O Peripherals



ST Microelectronics
 Title: STM32100EE_EVAL I/O Peripherals
 Number: MB991 Rev B.1 (PCB SCH) Date: 2/07/2011 Sheet 6 of 13

Figure 19. STM32100E-EVAL MicroSD and SPI Flash



ST Microelectronics
 Title: STM32100E-EVAL: MicroSD & SPI Flash
 Number: MB9001 | Rev. B: 1 | IP: CB, SCH | Date: 2/4/2011 | Sheet 7 of 13

Figure 20. STM32100E-EVAL RS-485, RS-232 and IrDA

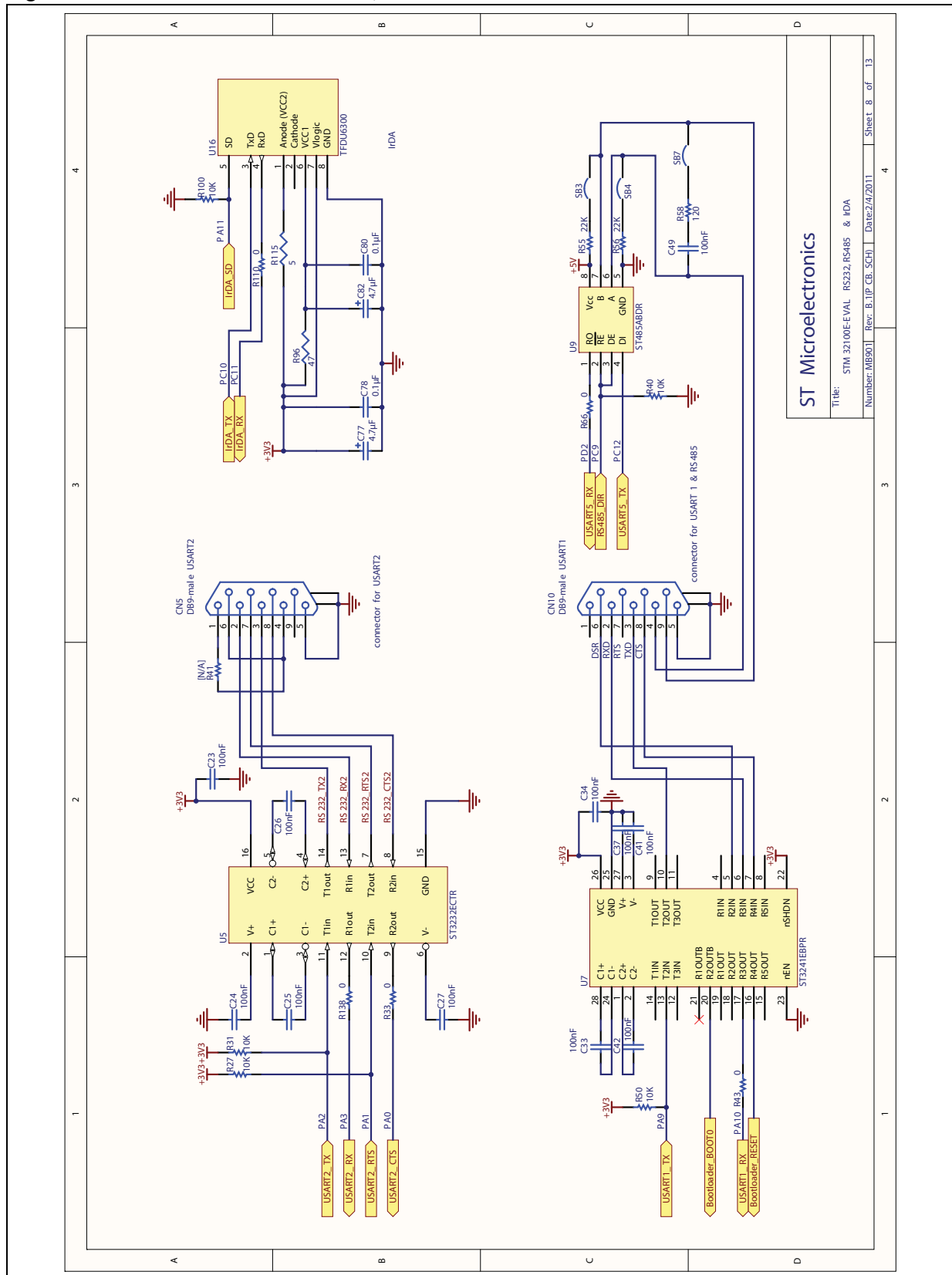

Figure 21. STM32100E-EVAL HDMI_CEC and IR receiver

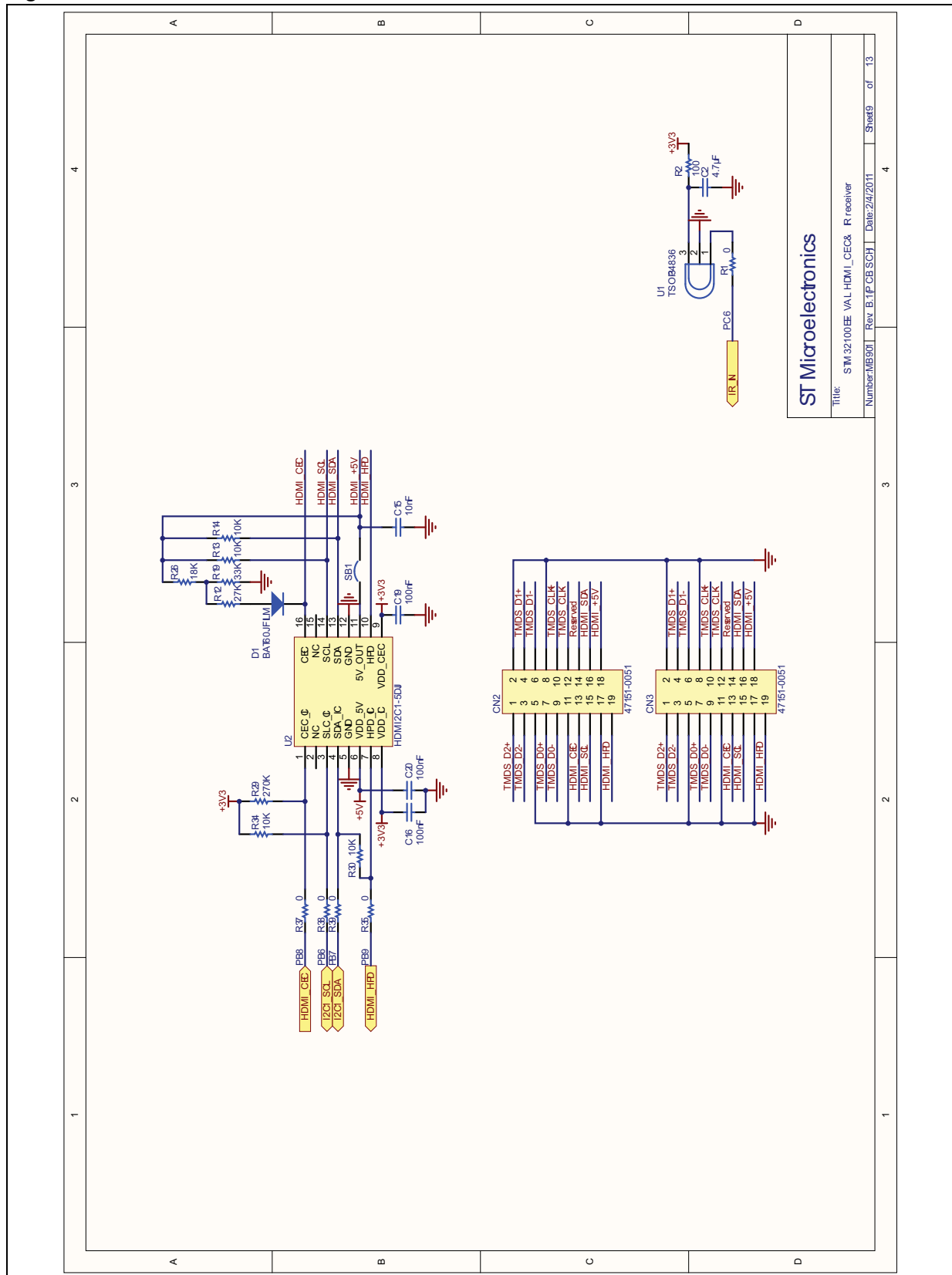

Figure 22. STM32100E-EVAL JTAG

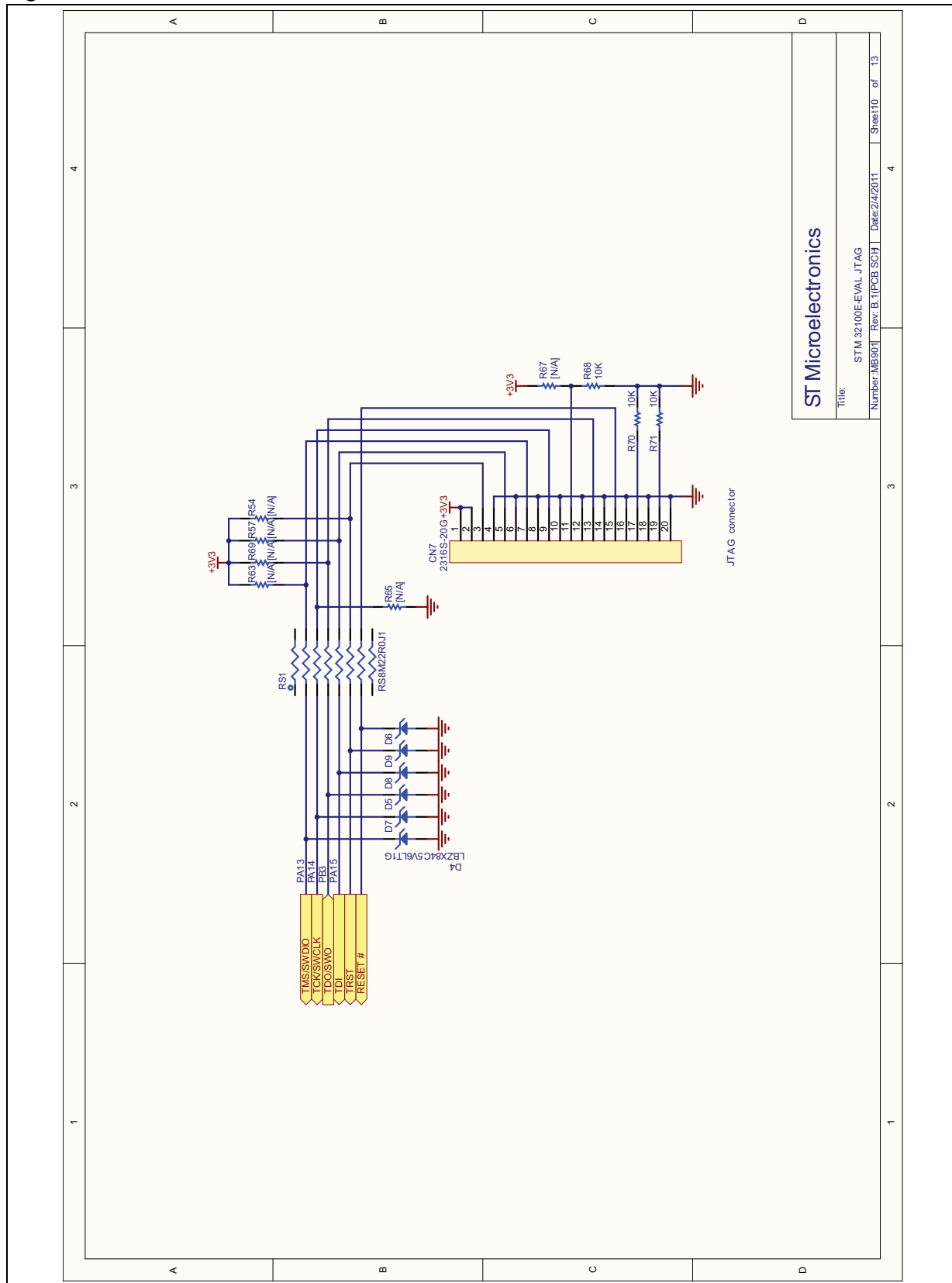

Figure 23. STM32100E-EVAL ST-LINK (JTAG only)

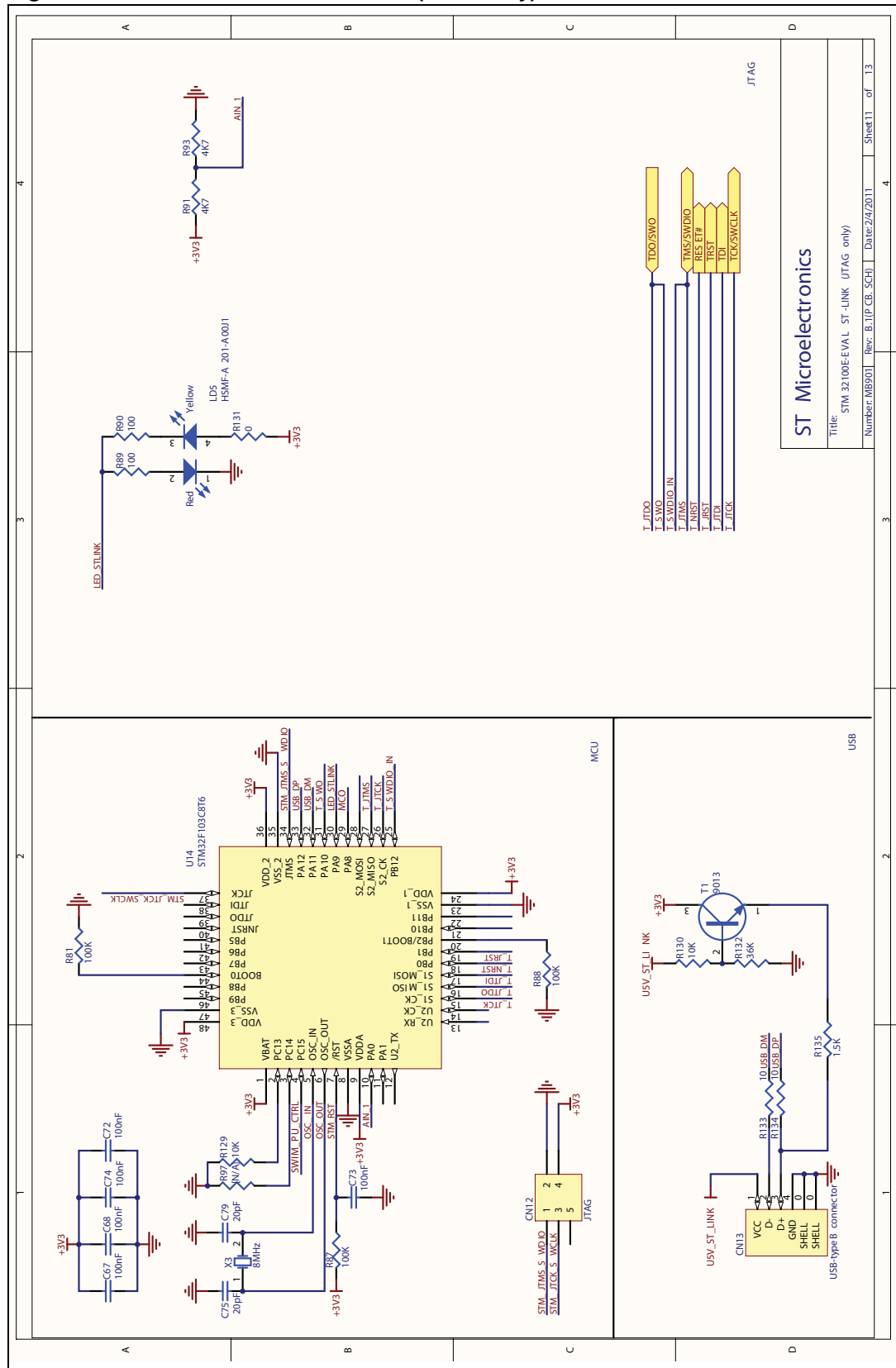
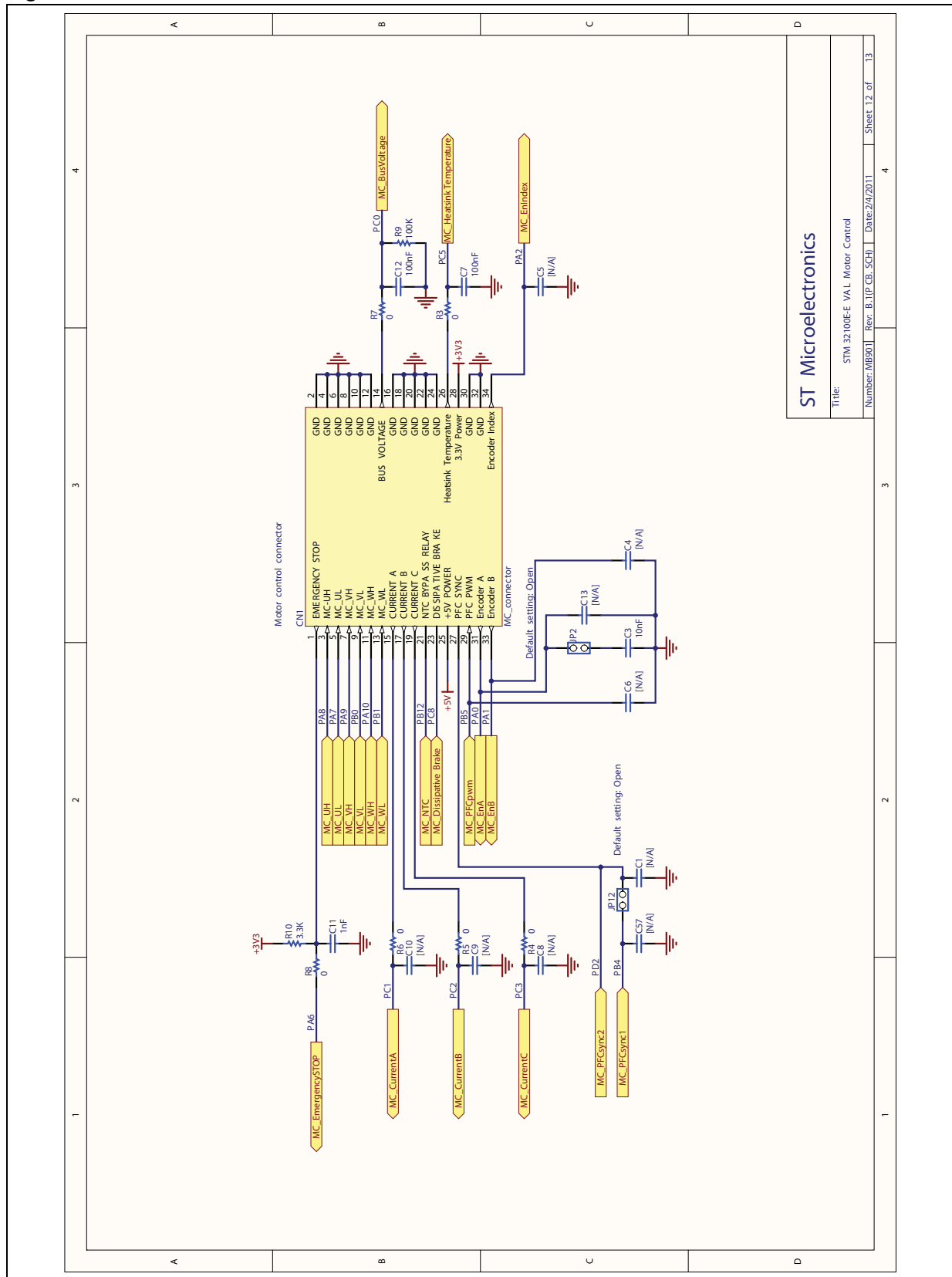
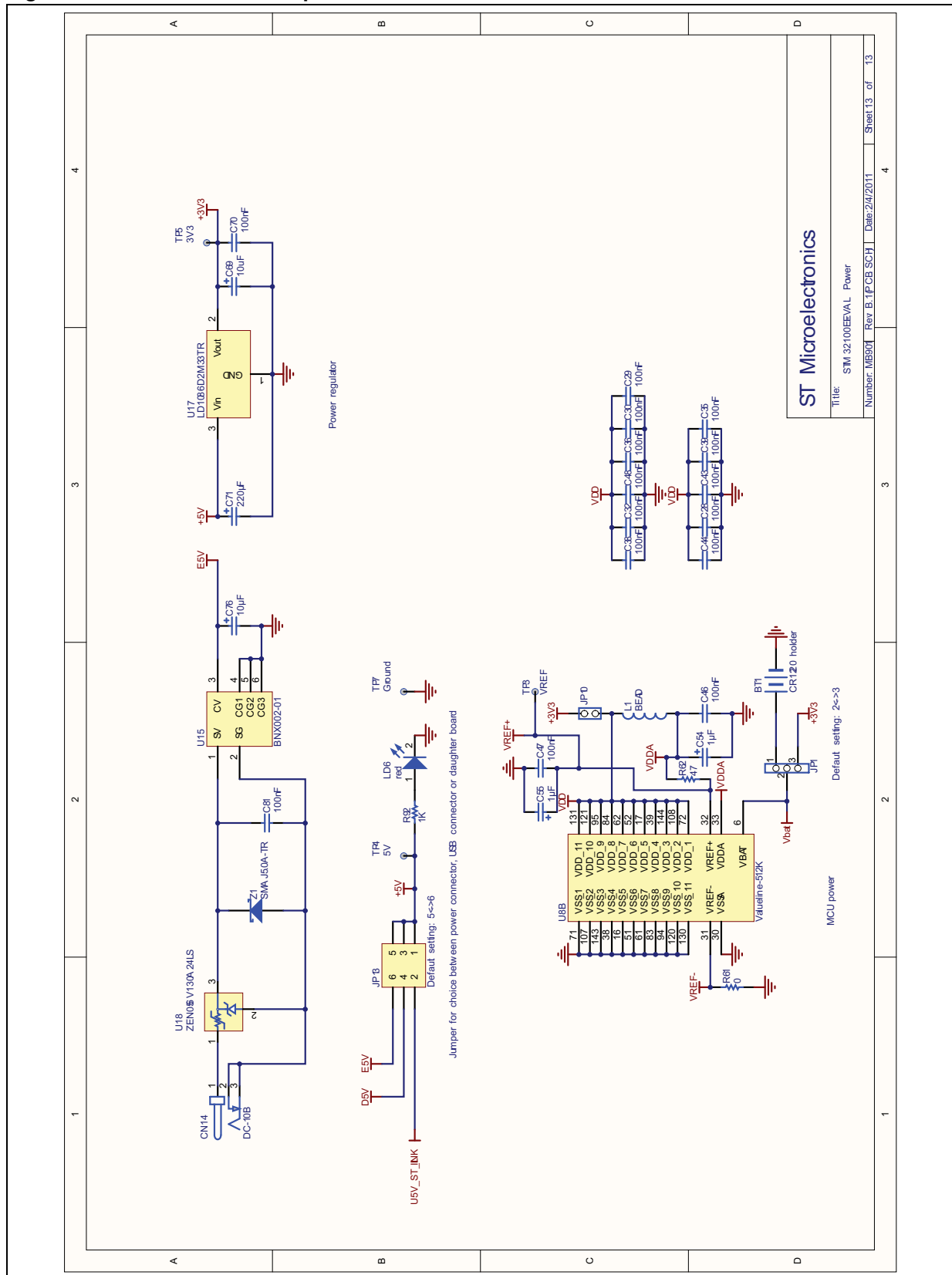

Figure 24. STM32100E-EVAL motor control



ST Microelectronics
 Title: STM32100E-E VAL Motor Control
 Number: MB901 Rev. B | IP: CB, SCH Date: 2/24/2011 Sheet 12 of 13

Figure 25. STM32100E-EVAL power



ST Microelectronics	
Title:	STM 32100EEVAL Power
Number:	M8901 Rev B.1 PCB SCH Date: 2/4/2011 Sheet 13 of 13

Appendix A STM32100E-EVAL pinout

Table 23. STM32100E-EVAL pinout

Pin no.	Pin name	Description
1	PE2	
2	PE3	FSMCA19
3	PE4	FSMCA20
4	PE5	
5	PE6	Flash_CS
6	VBAT	VBAT
7	PC13-ANTI_TAMP	Anti-tamper button
8	PC14-OSC32_IN	32K OSC
9	PC15-OSC32_OUT	32K OSC
10	PF0	FSMCA0
11	PF1	FSMCA1
12	PF2	FSMCA2
13	PF3	FSMCA3
14	PF4	FSMCA4
15	PF5	FSMCA5
16	VSS_5	
17	VDD_5	
18	PF6	LED1
19	PF7	LED2
20	PF8	LED3
21	PF9	LED4
22	PF10	
23	OSC_IN	
24	OSC_OUT	
25	NRST	
26	PC0	MC1_ADC_123_10 (Bus voltage)
27	PC1	MC1_ADC11 pin 15
28	PC2	MC1_ADC12 pin 17
29	PC3	MC1_ADC13 pin 19
30	VSSA	
31	VREF-	
32	VREF+	

Table 23. STM32100E-EVAL pinout (continued)

Pin no.	Pin name	Description
33	VDDA	
34	PA0-WKUP	MC1_TIM2_CH1 pin 31 (EnA) / Wakeup button / USART2 CTS
35	PA1	MC1_TIM2_CH2 pin 33 (EnB) / USART2 RTS
36	PA2	MC1_TIM2_CH3 pin34 (EnIndex) / USART2 TX
37	PA3	USART2 RX
38	VSS_4	
39	VDD_4	
40	PA4	DAC1_Audio / BNC
41	PA5	SPI_Flash_CLK / DAC2_Audio
42	PA6	MC1_STOP pin 1 (Emergency stop) / SPI_Flash_MISO
43	PA7	MC1_TIM5_CH1N pin 5 (UL) / SPI_Flash_MOSI
44	PC4	Potentiometer
45	PC5	MC1_ADC_12_15 pin 26
46	PB0	MC1_TIM5_CH2N pin 9 (VL)
47	PB1	MC1_TIM5_CH3N pin 13 (WL)
48	PB2	Boot1
49	PF11	MicroSD card detect
50	PF12	FSMCA6
51	VSS_6	
52	VDD_6	
53	PF13	FSMCA7
54	PF14	FSMCA8
55	PF15	FSMCA9
56	PG0	FSMCA10
57	PG1	FSMCA11
58	PE7	FSMCD4
59	PE8	FSMCD5
60	PE9	FSMCD6
61	VSS_7	
62	VDD_7	
63	PE10	FSMCD7
64	PE11	FSMCD8
65	PE12	FSMCD9
66	PE13	FSMCD10
67	PE14	FSMCD11

Table 23. STM32100E-EVAL pinout (continued)

Pin no.	Pin name	Description
68	PE15	FSMCD12
69	PB10	EEPROM_TS_IO_expandor_Audio_SCL2
70	PB11	EEPROM_TS_IO_expandor_Audio_SDA2
71	VSS_1	
72	VDD_1	
73	PB12	MC1_pin21 / Temperature SMBIA
74	PB13	SD_card_SCK
75	PB14	SD_card MISO
76	PB15	SD_card_MOSI
77	PD8	FSMCD13
78	PD9	FSMCD14
79	PD10	FSMCD15
80	PD11	FSMCA16
81	PD12	FSMCA17
82	PD13	FSMCA18
83	VSS_8	
84	VDD_8	
85	PD14	FSMCD0
86	PD15	FSMCD1
87	PG2	FSMCA12
88	PG3	FSMCA13
89	PG4	FSMCA14
90	PG5	FSMCA15
91	PG6	SD_card_CS
92	PG7	Joystick sel
93	PG8	User button
94	VSS_9	
95	VDD_9	
96	PC6	IR_receiver
97	PC7	LCD_backlight
98	PC8	MC_DissipativeBrake
99	PC9	RS485_DIR
100	PA8	MCO/MC_TIM1_CH1 pin 3 (UH)
101	PA9	MC_TIM1_CH2_pin7(VH)
102	PA10	MC_TIM2_CH3_pin11(WH) / USART1 RX

Table 23. STM32100E-EVAL pinout (continued)

Pin no.	Pin name	Description
103	PA11	IrDA_SD
104	PA12	IO_Expandor_INT
105	PA13	Debug TMS
106	NC	
107	VSS_2	
108	VDD_2	
109	PA14	Debug TCK
110	PA15	Debug TDI
111	PC10	IRDA TX
112	PC11	IRDA RX
113	PC12	RS485_TX5
114	PD0	FSMCD2
115	PD1	FSMCD3
116	PD2	MC1_TIM3_ETR pin 27 (PFCsync2) / RS485_RX5
117	PD3	FSMC_CLK
118	PD4	FSMCOEN
119	PD5	FSMCWEN
120	VSS_10	
121	VDD_10	
122	PD6	FSMCWAITN
123	PD7	
124	PG9	
125	PG10	FSMCEBAR2 SRAM
126	PG11	Joystick_down
127	PG12	FSMCEBAR3 LCD
128	PG13	Joystick_right
129	PG14	Joystick_left
130	VSS_11	
131	VDD_11	
132	PG15	Joystick_up
133	PB3	Debug TDO
134	PB4	Debug TRST/MC1_TIM3_CH1 pin 27 (PFCsync1)
135	PB5	MC1_TIM3_CH2 pin 29 (PFC pwm)
136	PB6	THDMI_SCL1
137	PB7	FSMC_NBAR / HDMI_SDA1

Table 23. STM32100E-EVAL pinout (continued)

Pin no.	Pin name	Description
138	BOOT0	
139	PB8	HDMI_CEC
140	PB9	HDMI_HPD
141	PE0	FSMCBLN0
142	PE1	FSMCBLN1
143	VSS_3	
144	VDD_3	

Revision history

Table 24. Document revision history

Date	Revision	Changes
23-Mar-2011	1	Initial release.
18-Sep-2012	2	Added Table 1: Applicable tools . Table 20: Daughterboard extension connector CN8 : updated shading for pins 9, 11, 48, and 49. Replaced Figure 26: STM32100E-EVAL (MB785) 3.2" LCD module with both SPI and 16 bit interface

Please Read Carefully:

Information in this document is provided solely in connection with ST products. STMicroelectronics NV and its subsidiaries ("ST") reserve the right to make changes, corrections, modifications or improvements, to this document, and the products and services described herein at any time, without notice.

All ST products are sold pursuant to ST's terms and conditions of sale.

Purchasers are solely responsible for the choice, selection and use of the ST products and services described herein, and ST assumes no liability whatsoever relating to the choice, selection or use of the ST products and services described herein.

No license, express or implied, by estoppel or otherwise, to any intellectual property rights is granted under this document. If any part of this document refers to any third party products or services it shall not be deemed a license grant by ST for the use of such third party products or services, or any intellectual property contained therein or considered as a warranty covering the use in any manner whatsoever of such third party products or services or any intellectual property contained therein.

UNLESS OTHERWISE SET FORTH IN ST'S TERMS AND CONDITIONS OF SALE ST DISCLAIMS ANY EXPRESS OR IMPLIED WARRANTY WITH RESPECT TO THE USE AND/OR SALE OF ST PRODUCTS INCLUDING WITHOUT LIMITATION IMPLIED WARRANTIES OF MERCHANTABILITY, FITNESS FOR A PARTICULAR PURPOSE (AND THEIR EQUIVALENTS UNDER THE LAWS OF ANY JURISDICTION), OR INFRINGEMENT OF ANY PATENT, COPYRIGHT OR OTHER INTELLECTUAL PROPERTY RIGHT.

UNLESS EXPRESSLY APPROVED IN WRITING BY TWO AUTHORIZED ST REPRESENTATIVES, ST PRODUCTS ARE NOT RECOMMENDED, AUTHORIZED OR WARRANTED FOR USE IN MILITARY, AIR CRAFT, SPACE, LIFE SAVING, OR LIFE SUSTAINING APPLICATIONS, NOR IN PRODUCTS OR SYSTEMS WHERE FAILURE OR MALFUNCTION MAY RESULT IN PERSONAL INJURY, DEATH, OR SEVERE PROPERTY OR ENVIRONMENTAL DAMAGE. ST PRODUCTS WHICH ARE NOT SPECIFIED AS "AUTOMOTIVE GRADE" MAY ONLY BE USED IN AUTOMOTIVE APPLICATIONS AT USER'S OWN RISK.

Resale of ST products with provisions different from the statements and/or technical features set forth in this document shall immediately void any warranty granted by ST for the ST product or service described herein and shall not create or extend in any manner whatsoever, any liability of ST.

ST and the ST logo are trademarks or registered trademarks of ST in various countries.

Information in this document supersedes and replaces all information previously supplied.

The ST logo is a registered trademark of STMicroelectronics. All other names are the property of their respective owners.

© 2012 STMicroelectronics - All rights reserved

STMicroelectronics group of companies

Australia - Belgium - Brazil - Canada - China - Czech Republic - Finland - France - Germany - Hong Kong - India - Israel - Italy - Japan - Malaysia - Malta - Morocco - Philippines - Singapore - Spain - Sweden - Switzerland - United Kingdom - United States of America

www.st.com